

ART OF MATHEMATICS  
DISCOVERING THE



THE INFINITE

MATHEMATICAL INQUIRY IN THE LIBERAL ARTS



Julian F. Fleron  
with Volker Ecke, Philip K. Hotchkiss and Christine von Renesse



# Discovering the Art of Mathematics

## The Infinite

by Julian F. Fleron

with Volker Ecke, Philip K. Hotchkiss,  
and Christine von Renesse

2013



FIGURE 1. “Infinite Study Guide”; original acrylic on canvas by **Brianna Lyons** (American student and graphic designer; - )

Working Draft: May be copied and distributed for educational purposes only. Such use requires notification of the authors. (Send email to [jfleron@westfield.ma.edu](mailto:jfleron@westfield.ma.edu) .) Not for any other quotation or distribution without written consent of the authors.

For more information about this manuscript or the larger project to develop a library of 10 inquiry-based guides, please see <http://artofmathematics.westfield.ma.edu/>.



## Acknowledgements

Original drafts of part of these materials were developed with partial financial support from the Teaching Grant Program at Westfield State College.



Subsequent work on these materials is based upon work supported by the National Science Foundation under award NSF0836943. Any opinions, findings, and conclusions or recommendations expressed in this publication are those of the author(s) and do not necessarily reflect the views of the National Science Foundation.

These materials are also based on work supported by Project PRIME which was made possible by a generous gift from Mr. Harry Lucas.

The author would like to thank both his immediate and extended family for continual inspiration, support, and love. He would also like to thank Robert Martin of the Office of Academic Affairs for financial and intellectual support and many colleagues on the Westfield State College/University campus, particularly James Robertson, Robert McGuigan, and Maureen Bardwell for mathematical guidance and inspiration.

Rumara Jewett and Jim Robertson provided detailed feedback on first drafts of these materials. Thanks to Gizem Karaali for detailed review of the full volume.

Most importantly, the author would like to thank the students in many different Mathematical Explorations courses at Westfield State College/University that have explored this material as it was developed and refined.



Somewhere something incredible is waiting to be known.

**Carl Sagan** (American astronomer and author; 1934 - 1996)

Live as if you were going to die tomorrow.

Learn as if you were going to live forever.

**Mahatma Gandhi** (Indian revolutionary and philosopher; 1869 - 1948)

Imagination is more important than knowledge.

**Albert Einstein** (German physicist, philosopher, and author; 1879 - 1955)

Tell me and I'll forget.

Show me and I may not remember.

Involve me, and I'll understand.

**Native American Saying**





## Preface: Notes to the Explorer

Yes, that's you - you're the explorer.

"Explorer?"

Yes, explorer. And these notes are for you.

We could have addressed you as "reader," but this is not a traditional book. Indeed, this book cannot be read in the traditional sense. For this book is really a guide. It is a map. It is a route of trail markers along a path through part of the world of mathematics. This book provides you, our explorer, our heroine or hero, with a unique opportunity to explore this path - to take a surprising, exciting, and beautiful journey along a meandering path through a mathematical continent named the infinite. And this is a vast continent, not just one fixed, singular locale.

"Surprising?" Yes, surprising. You will be surprised to be doing real mathematics. You will not be following rules or algorithms, nor will you be parroting what you have been dutifully shown in class or by the text. Unlike most mathematics textbooks, this book is not a transcribed lecture followed by dozens of exercises that closely mimic illustrative examples. Rather, after a brief introduction to the chapter, the majority of each chapter is made up of Investigations. These investigations are interwoven with brief surveys, narratives, or introductions for context. But the Investigations form the heart of this book, your journey. In the form of a Socratic dialogue, the Investigations ask you to explore. They ask you to discover the infinite. This is not a sightseeing tour, you will be the active one here. You will see mathematics the only way it can be seen, with the eyes of the mind - your mind. You are the mathematician on this voyage.

"Exciting?" Yes, exciting. Mathematics is captivating, curious, and intellectually compelling if you are not forced to approach it in a mindless, stress-invoking, mechanical manner. In this journey you will find the mathematical world to be quite different from the static barren landscape most textbooks paint it to be. Mathematics is in the midst of a golden age - more mathematics is discovered each day than in any time in its long history. Each year there are 50,000 mathematical papers and books that are reviewed for *Mathematical Reviews!* *Fermat's Last Theorem*, which is considered in detail in Discovering that Art of Mathematics - Number Theory, was solved in 1993 after 350 years of intense struggle. The 1\$ Million Poincaré conjecture, unanswered for over 100 years, was solved by **Grigori Perelman** (Russian mathematician; 1966 - ). In the time period between when these words were written and when you read them it is quite likely that important new discoveries adjacent to the path laid out here have been made.

"Beautiful?" Yes, beautiful. Mathematics is beautiful. It is a shame, but most people finish high school after 10 - 12 years of mathematics *instruction* and have no idea that mathematics is beautiful. How can this happen? Well, they were busy learning mathematical skills, mathematical reasoning, and mathematical applications. Arithmetical and statistical skills are useful skills everybody should possess. Who could argue with learning to reason? And we are all aware, to some degree or another, how mathematics shapes our technological society. But there is something more to mathematics than its usefulness and utility. There is its beauty. And the beauty of mathematics is one of its driving forces. As the famous **Henri Poincaré** (French mathematician; 1854 - 1912) said:

The mathematician does not study pure mathematics because it is useful; [s]he studies it because [s]he delights in it and [s]he delights in it because it is beautiful.

Mathematics plays a dual role as both a liberal art and as a science. As a powerful science, mathematics shapes our technological society and serves as an indispensable tool and language in many fields. But it is not our purpose to explore these roles of mathematics here. This has been done in many other fine, accessible books (e.g. [COM] and [TaAr]). Instead, our purpose here is to journey down a path that values mathematics from its long tradition as a cornerstone of the liberal arts.

Mathematics was the organizing principle of the *Pythagorean society* (ca. 500 B.C.). It was a central concern of the great Greek philosophers like **Plato** (Greek philosopher; 427 - 347 B.C.). During the Dark Ages, classical knowledge was rescued and preserved in monasteries. Knowledge was categorized into the

classical liberal arts and mathematics made up several of the seven categories.<sup>1</sup> During the Renaissance and the Scientific Revolution the importance of mathematics as a science increased dramatically. Nonetheless, it also remained a central component of the liberal arts during these periods. Indeed, mathematics has never lost its place within the liberal arts - except in the contemporary classrooms and textbooks where the focus of attention has shifted solely to the training of qualified mathematical scientists. If you are a student of the liberal arts or if you simply want to study mathematics for its own sake, you should feel more at home on this exploration than in other mathematics classes.

“Surprise, excitement, and beauty? Liberal arts? In a mathematics textbook?” Yes. And more. In your exploration here you will see that mathematics is a human endeavor with its own rich history of human struggle and accomplishment. You will see many of the other arts in non-trivial roles: art and music to name two. There is also a fair share of philosophy and history. Students in the humanities and social sciences, you should feel at home here too.

Mathematics is broad, dynamic, and connected to every area of study in one way or another. There are places in mathematics for those in all areas of interest.

The great **Bertrand Russell** (English mathematician and philosopher; 1872 - 1970) eloquently observed:

Mathematics, rightly viewed, possesses not only truth, but supreme beauty - a beauty cold and austere, like that of sculpture, without appeal to any part of our weaker nature, without the gorgeous trappings of paintings or music, yet sublimely pure and capable of a stern perfection such as only the greatest art can show.

It is my hope that your discoveries and explorations along this path through the infinite will help you glimpse some of this beauty. And I hope they will help you appreciate Russell’s claim that:

... The true spirit of delight, the exaltation, the sense of being more than [hu]man, which is the touchstone of the highest excellence, is to be found in mathematics as surely as in poetry.

Finally, it is my hope that these discoveries and explorations enable you to make mathematics a real part of your lifelong educational journey. For, in Russell’s words once again:

... What is best in mathematics deserves not merely to be learned as a task but to be assimilated as a part of daily thought, and brought again and again before the mind with ever-renewed encouragement.

Bon voyage. May your journey be as fulfilling and enlightening as those that have served as beacons to people who have explored the continents of mathematics throughout history.

---

<sup>1</sup>These were divided into two components: the *quadrivium* (arithmetic, music, geometry, and astronomy) and the *trivium* (grammar, logic, and rhetoric); which were united into all of knowledge by philosophy.

The fear of infinity is a form of myopia that destroys the possibility of seeing the actual infinite, even though it in its highest form has created and sustains us, and in its secondary transfinite forms occurs all around us and even inhabits our minds.

**Georg Cantor** (German Mathematician; 1845 - 1918)

I am so in favor of the actual infinite that instead of admitting that Nature abhors it, as is commonly said, I hold that Nature makes frequent use of it everywhere, in order to show more effectively the perfections of its Author. Thus I believe that there is no part of matter which is not - I do not say divisible - but actually divisible; and consequently the least particle ought to be considered as a world full of an infinity of different creatures.

**George Cantor**



## Navigating This Book

Before you begin, it will be helpful for us to briefly describe the set-up and conventions that are used throughout this book.

As noted in the Preface, the fundamental part of this book is the Investigations. They are the sequence of problems that will help guide you on your active exploration of mathematics. In each chapter the investigations are numbered sequentially. You may work on these investigation cooperatively in groups, they may often be part of homework, selected investigations may be solved by your teacher for the purposes of illustration, or any of these and other combinations depending on how your teacher decides to structure your learning experiences.

If you are stuck on an investigation remember what **Frederick Douglass** (American slave, abolitionist, and writer; 1818 - 1895) told us: “If thee is no struggle, there is no progress.” Keep thinking about it, talk to peers, or ask your teacher for help. If you want you can temporarily put it aside and move on to the next section of the chapter. The sections are often somewhat independent.

Investigation numbers are bolded to help you identify the relationship between them.

Independent investigations are so-called to point out that the task is more significant than the typical investigations. They may require more involved mathematical investigation, additional research outside of class, or a significant writing component. They may also signify an opportunity for class discussion or group reporting once work has reached a certain stage of completion.

The Connections sections are meant to provide illustrations of the important connections between mathematics and other fields - especially the liberal arts. Whether you complete a few of the connections of your choice, all of the connections in each section, or are asked to find your own connections is up to your teacher. But we hope that these connections will help you see how rich mathematics’ connections are to the liberal arts, the fine arts, culture, and the human experience.

Further investigations, when included are meant to continue the investigations of the area in question to a higher level. Often the level of sophistication of these investigations will be higher. Additionally, our guidance will be more cursory.

Within each book in this series the chapters are chosen sequentially so there is a dominant theme and direction to the book. However, it is often the case that chapters can be used independently of one another - both within a given book and among books in the series. So you may find your teacher choosing chapters from a number of different books - and even including “chapters” of their own that they have created to craft a coherent course for you. More information on chapter dependence within single books is available online.

Certain conventions are quite important to note. Because of the central role of proof in mathematics, definitions are essential. But different contexts suggest different degrees of formality. In our text we use the following conventions regarding definitions:

- An *undefined term* is italicized the first time it is used. This signifies that the term is: a standard technical term which will not be defined and may be new to the reader; a term that will be defined a bit later; or an important non-technical term that may be new to the reader, suggesting a dictionary consultation may be helpful.
- An *informal definition* is italicized and bold faced the first time it is used. This signifies that an implicit, non-technical, and/or intuitive definition should be clear from context. Often this means that a formal definition at this point would take the discussion too far afield or be overly pedantic.
- A **formal definition** is bolded the first time it is used. This is a formal definition that suitably precise for logical, rigorous proofs to be developed from the definition.

In each chapter the first time a biographical name appears it is bolded and basic biographical information is included parenthetically to provide some historical, cultural, and human connections.



# Contents

Acknowledgements	v
	vii
Preface: Notes to the Explorer	ix
Navigating This Book	xiii
Introduction: The Infinite and New Number Systems	1
1. Overcoming Fear	1
2. The Power of Ideas	2
3. Understanding the Infinite is a Necessary Prerequisite for Understanding Number.	2
4. Mathematics: The Game of Thought	3
5. Enlightenment	4
Chapter 1. The Very Large...	5
1. Large Numbers and the Sand Reckoner	5
2. Large Numbers and Everyday Things	7
3. A Trillion Dollars in Human Terms	7
4. Innumeracy	8
5. Names of Some Really Large Numbers	9
6. Exponential Growth and Really Large Numbers	9
7. Connections	11
Chapter 2. ...and Beyond	15
1. Sets and Infinity	17
2. A Set of Set Exercises	17
3. Infinite Arithmetic	18
4. The Wheel of Aristotle	19
5. Zeno's Paradox of Motion	20
6. Non-Convergence in Measure	21
7. Connections	22
Chapter 3. Grasping Infinity	25
1. Algebra and Infinitely Repeated Decimals	25
2. $0.999\dots$ and 1	26
3. More Infinite Decimals	26
4. Another Infinite Objects	26
5. Infinite Objects - Numerically	27
6. Infinite Objects - Algebraically	28
7. Infinite Objects - Geometrically	28
8. A Caveat on the Infinite	31
Chapter 4. Rigor and Divergence	33
1. Zeno Redux	34
2. Divergent Series	36
3. Devilish Series	37
4. Gabriel's Wedding Cake	39
5. Connections	41
6. Further Investigations	42

Chapter 5. Sizes of Infinity	45
1. Counting	45
2. Counting by Matching	46
3. Comparing Infinite Sets	47
4. Sets of Sets	48
5. Cantor's Theorem and Transfinite Cardinal Numbers	49
6. Hilbert's Hotel	50
7. Nondenumerability of the Continuum	52
8. The Continuum Hypothesis	53
9. Further Investigations	55
Chapter 6. Georg Cantor: Champion of the Infinite	57
Chapter 7. The Ordered and Surreal Landscapes of Infinity	61
1. What's Next?	61
2. The Ordinal Numbers	61
3. The Surreal Numbers	62
4. Genesis of the Surreal Numbers	63
5. The Hackenbush Game	64
Index	67



## Introduction: The Infinite and New Number Systems

The infinite! No other question has ever moved so profoundly the spirit of man.

**David Hilbert** (; -)

To see the world in a grain of sand,  
And heaven in a wild flower;  
Hold infinity in the palm of your hand,  
And eternity in an hour.

**William Blake** (; -)

The infinite is a mathematical and philosophical wonder that has beckoned the human intellect from the earliest of times. Whether in relation to the apparent endlessness of space and time, the identification of the infinite with God or Gods, or the unending divisibility of a line into smaller and smaller parts, the infinite has stirred the imaginations of the smallest children, the greatest philosophers, common (wo)men, and the most imminent mathematicians. The place of the infinite in the history of human thought makes it a worthy and compelling topic.

There are many other reasons that we can give to motivate the study of the infinite - underlying themes of this book.

### 1. Overcoming Fear

In the quote on the frontispiece **Georg Cantor** (; -) called our fear of infinity “a myopia that destroys the possibility of seeing the actual infinite.” In the Arts and Humanities there has been no so fear. Poets have always been happy to write about the infinite. Artists have long used the infinite in their work - in perspective drawing for one example. Clerics used it describing their faith; **Saint Augustine** (; -) said, “Every infinity is made finite to God.” In sharp contrast, the philosophers deemed part of *metaphysics*. The scientists and mathematicians were much harsher, attempting to banish it from the realm of their subjects:

I protest above all against the use of an infinite quantity as a completed one, which in mathematics is never allowed. The Infinite is only a manner of speaking.

**Carl Friedrich Gauss** (; -)

Gauss is one of the greatest mathematicians of all time.

Infinities and indivisibles transcend our finite understanding, the former on account of their magnitude, the latter because of their smallness; Imagine what they are when combined.

**Galileo** (; -)

Imagine, one of the most important figures in the Scientific Revolution - a period which provoked radical changes in the way we think about our world - saying that the infinite transcends our understanding.

In fact, as we shall see, it does not. The visionary work of Cantor led to two new number systems, the *transfinite cardinals* and the *transfinite ordinals*, both of which include *infinitely many different infinite numbers*. His work in these areas has been called

... the finest product of mathematical genius and one of the supreme achievements of purely intellectual human activity.<sup>2</sup>

**David Hilbert** (; -)

The infinite, says **Shaughan Lavine** (; -):

... has been one of the main nutrients for the spectacular flowering of mathematics in the twentieth century.

If we can understand the infinite, are there any limits to what we can understand? Are we too quick to demonize what we think we cannot understand? How much do our prejudices constrain our reasoning and imagination? What other “myopias” keep us from seeing what is really there?

---

<sup>2</sup>Quoted in The History of Mathematics by David Burton.

These are important questions in any area of study; the history of the infinite provides us with an enlightening example.

## 2. The Power of Ideas

Most of the fundamental ideas of a science are essentially simple, and may, as a rule, be expressed in a language comprehensible to everyone.

Albert Einstein ( ; - )

Why do people risk their lives to climb Mount Everest. “Because it is there” goes the popular saying. Well, the infinite is there too. You do not need to risk your life to explore it. You simply need to use your mind, your imagination, you need to reason. Your exploration is cerebral.

Climbing mountains is good for the body, within reason, and probably good for the soul. If we are to think, to learn, or to pursue any real intellectual pursuit we must explore and generate ideas. **Linus Pauling** (American chemist, activist, and author; 1901 - 1994), one of only two people to win Nobel prizes in two different areas - his were Chemistry and Peace - reminds us:

In order to have a good idea, you must have lots of ideas.

Your exploration here is meant to provoke many ideas - some good, some bad. It is also meant to help you understand some of the most fantastic ideas of all time.

The basis of Cantor’s work on the infinite were “essentially simple” as Einstein said they should be. He considered the basic question, “How many?” Insightfully he saw that he could quantify this question by simple matching. He then proceeded logically to develop the *transfinite cardinal numbers*. Starting with the equally basic question, “What’s next?” he similarly developed the *transfinite ordinal numbers*. Attacked by many, as we shall see, he defended his theories:

My theory stands as firm as a rock; every arrow directed against it will return quickly to its archer. How do I know this? Because I have studied it from all sides for many years; because I have examined all objections which have ever been made against the infinite numbers; and above all because I have followed its roots, so to speak, to the first infallible cause of all created things.

We agree with **Seymour Papert** (American educator; - ) who tells us:

What matters most is...one comes to appreciate how certain ideas can be used as tools to think with over a lifetime. One learns to enjoy and respect the power of powerful ideas. One learns that the most powerful idea of all is the idea of powerful ideas.<sup>3</sup>

## 3. Understanding the Infinite is a Necessary Prerequisite for Understanding Number.

The sections above motivate the infinite for somewhat general reasons, with full knowledge that these motivations have had significant import in mathematics itself as well. Here we provide a motivation that is purely mathematical. One that is absolutely fundamental.

Number seems like a naive, *a priori* notion. Yet the history of number does not bear this out. **Erwin Schrodinger** (Physicist; - ) reminds us:

The idea of the continuum [i.e. the number line] seems simple to us. We have somehow lost sight of the difficulties it implies...We are told such a number as 2 worried Pythagoras and his school almost to exhaustion. Being used to such queer numbers from early childhood, we must be careful not to form a low idea of the mathematical intuition of these ancient sages, their worry was highly credible.

Here are some short vignettes of the tumultuous history of number:

- The *Pythagorean order* (circa 550 B.C.) was a strict, secret society we might call a cult in contemporary terms. Their order revolved around intellectual, philosophical, and religious pursuits. Central to all these pursuits was their motto “All is number.” It was widely believed, and central to the Pythagorean faith, that all lengths could be described as ratios, or fractions, of whole numbers. The discovery that  $\sqrt{2}$ , the length of the diagonal of a square with one unit sides, is *incommensurable* - inadequately described by ratios of whole numbers, “virtually demolished the basis for the Pythagorean faith in whole numbers.”<sup>4</sup> The discovery of such numbers, now called *irrationals*, was a “logical scandal” of such magnitude that “Popular legend has it that the first Pythagorean to utter the unutterable [the existence of incommensurables] to an outsider was

---

<sup>3</sup>From *Mindstorms: Children, Computers and Powerful Ideas*.

<sup>4</sup>Carl B. Boyer, in *A History of Mathematics*, John Wiley & Sons, 1968, p. 79.

murdered – thrown off a ship to drown.”<sup>5</sup> The infinite is central to an understanding of the nature of the irrationals.

- As early as the first several centuries in the modern age Indian, Islamic and Chinese mathematicians utilized negative numbers. However, most European mathematicians considered them to be “absurd numbers,” as Nicolas Choquet called them, well into the eighteenth century.
- The crises initiated by the discovery of incommensurables has a lengthy history. In fact, close to two millennia later the invention of calculus was mired in related difficulties caused by the lack of a understanding of the *infinitesimal*, or infinitely small. These difficulties prompted Bishop George Berkeley to write a scathing attack on the “infidel mathematicians” in which he sneered, “And what are these same evanescent increments [infinitesimals]? They are neither finite quantities, nor quantities infinitely small, nor yet nothing. May we not call them the ghosts of departed quantities?”<sup>6</sup> These difficulties were not overcome until the nineteenth century *Age of Analysis* which saw many of history’s greatest mathematicians focus their efforts on the nature of the infinite in the mathematical analysis of number.
- Lessons on square roots are usually replete with strenuous reminders not to attempt the square root of negative numbers. Since positive times positive yields positive, as does negative times negative, the square root of a negative number must be nonsensical the reasoning goes. In fact, seventeenth century mathematicians hesitantly began to realize *complex, or imaginary, numbers* such as  $\sqrt{-1}$  were extremely useful.<sup>7</sup> These numbers, called “a fine and wonderful refuge of the divine spirit - almost an amphibian between being and non-being” by **G.W. Leibniz** (; -),<sup>8</sup> have critical implications to the coherence and unity of many branches of mathematics. One simple example is the quadratic formula  $\frac{-b \pm \sqrt{b^2 - 4ac}}{2a}$ . In the setting of complex numbers, this formula provides two solutions of the *quadratic equation*  $ax^2 + bx + c = 0$  without any worry about  $\sqrt{b^2 - 4ac}$  involving a negative in the radical.
- Cantor’s work on the infinite was motivated by practical mathematical questions that he was considering. One of the surprising outcomes of his work is that those numbers that make up the solutions to algebraic equations are an infinitesimal proportion of all real numbers. Said differently, *almost all*<sup>9</sup> real numbers are not solutions to algebraic equations with rational coefficients, they are *transcendental numbers*. The first number to be proven transcendental was around 1850 and by the time Cantor showed that almost all numbers were transcendental, only a few actual transcendentals were known. The proofs that  $\pi$  and  $e$  are transcendental are celebrated results that were quite difficult to obtain. To this day, our ability to construct transcendental numbers and to check whether given numbers are transcendental is very limited.

We cannot understand the irrationals, the transcendentals, or the calculus without understanding the infinite. Each involve infinite processes - which are fundamental to modern mathematics and generally cannot be understood without the work of Cantor.

#### 4. Mathematics: The Game of Thought

I love mathematics not only for its technical applications, but principally because it is beautiful; because man has breathed his spirit of play into it, and because it has given him his greatest game - the encompassing of the infinite.

**Rosza Peter** (Hungarian mathematician; 1905 - 1977)

Rosza Peter was an important founder of *recursion theory*. She was the first woman to become an academic doctor of Mathematics in Hungary - a hotbed of twentieth century mathematics. She struggled a great deal against Nazi oppression in the Second World War. A teacher in addition to her research career, she wrote Playing with Infinity: Mathematical Explorations and Excursions. It is a wonderful little book. The book you have in front of you shares many of the goals of this earlier book - we just hope to get you much more actively involved with the playing and exploration.

<sup>5</sup>David M. Burton, in *The History of Mathematics*, Allyn and Bacon, Inc. Newton, MA, 1985, p. 123.

<sup>6</sup>from Berkeley’s “The Analyst: Or a Discourse Addressed to the Infidel Mathematician”, 1734.

<sup>7</sup>We denote this particular imaginary number by the symbol  $i$ . It has striking properties. Among them is the equality  $e^{i\pi} + 1 = 0$  which not only unifies the five most critical numbers in mathematics: 0, 1,  $e$ ,  $i$ , and  $\pi$ ; but it also unites the most important relations and operations: equality, addition, multiplication, multiplication and exponentiation.

<sup>8</sup>Leibniz as well known in many areas. He was a diplomat, philosopher, lawyer, mathematician, and scientist. Among his notable accomplishments was the invention of calculus independently from **Isaac Newton** (; -).

<sup>9</sup>This term has a formal mathematical definition. Here it is equivalent to saying that if you pick a number truly at random from the number line the probability that it will be transcendental is 100%.

You may not associate the word “playing” with mathematics. But it is a word that is used quite often by mathematicians. And mathematicians are quite fond of games of all sorts. In this series we have an entire book devoted to puzzles and games.<sup>10</sup> We hope that you will find much of your exploration to be like play, like a game.

But we even end with an actual game - the *Hackenbush game*. This is an actual game which was developed by **John Horton Conway** (English mathematician; - ) as a way to construct the *surreal numbers* - a system of numbers that include both the infinitely large (Cantor’s ordinals) and the infinitesimally small. With a game!

## 5. Enlightenment

Which of these motivations, or others you might find on your exploration, is most compelling to you, we hope you will find:

The study of infinity is much more than a dry academic game. The intellectual pursuit of the absolute infinity is, as Georg Cantor realized, a form of the souls quest for God. Whether or not the goal is ever reached, an awareness of the process brings enlightenment.<sup>11</sup>

**Rudy Rucker** (; - )

---

<sup>10</sup>Not surprisingly entitled Discovering the Art of Puzzles and Games.

<sup>11</sup>From Infinity and the Mind.

## CHAPTER 1

# The Very Large...

Behold a Universe so immense that I am lost in it. I no longer know where I am. I am just nothing at all. Our world is terrifying in its insignificance.

**Bernard de Fontenelle** (French Author; 1657 - 1757)

Words of wisdom are spoken by children at least as often as by scientists. The name “googol” was invented by a child (Dr. Kasner’s nine-year-old nephew, Milton Sirotta) who was asked to think up a name for a very big number, namely, 1 with a hundred zeros after it. He was very certain that this number was not infinite, and therefore equally sure that it had to have a name. At the same time that he suggested “googol” he gave a name for a still larger number: “Googolplex.”<sup>1</sup>

**Edward Kasner** (American Mathematician; 1878 - 1955)

**James Newman** (American Mathematician and Lawyer; 1907 - 1966)

### 1. Large Numbers and the Sand Reckoner

Mathematics has always been used as a tool to describe the world we live in. Although this aspect is far from its sole purpose, it is important. Much of this importance arises from the ability of mathematics to answer quantitative questions: how big, how high, how heavy, how strong, etc.

In a quantitative sense, the infinite must transcend everything that is finite. In terms of numbers, it must be larger than any finite number no matter how large. If we are to appreciate the infinite, a good place to start is by appreciating large numbers.

In early times quantifying large magnitudes was difficult. Such a task was considered in detail by the great Greek mathematician **Archimedes** (Greek Mathematician, Physicist, Astronomer, Engineer and Inventor; circa 287 B.C. - circa 212 B.C.) in the “Sand Reckoner”<sup>2</sup>:

There are some, King Gelon, who think that the number of the [grains of] sand is infinite in multitude; and I mean by the sand not only that which exists about Syracuse and the rest of Sicily but also that which is found in every region whether inhabited or uninhabited... But I will try to show you by means of geometrical proofs, which you will be able to follow, that, of the numbers named by me and given in the work which I sent to Zeuxippus, some exceed not only the number of the mass of sand equal in magnitude to the earth filled up in the way described, but also that of a mass equal in magnitude to the universe.

Let us update Archimedes somewhat and find a number so large that it exceeds the number of molecules in the entire *observable universe*.

Of course, we must base our calculation on some theory of the universe.<sup>3</sup> The prevailing scientific theory, the so-called *Big Bang Theory*, suggests that the universe began as a giant explosion some 15 billion years ago. According to Einstein’s *Theory of Relativity*, the maximum velocity that matter can travel is the **speed of light**: approximately  $2.9979 \times 10^8 \frac{m}{sec}$ . The *observable universe*, the region from which light can reach us, is therefore a very large sphere. How big might this sphere be? Our figure for the age of the universe is in years, so we would like to convert the speed of light to a yearly distance. As there are 60 seconds in a minute we can convert the speed of light to a distance per minute as follows:

$$\text{Speed of light} \approx \left(2.9979 \times 10^8 \frac{m}{sec}\right) \left(60 \frac{sec}{min}\right) = 1.79874 \times 10^{10} \frac{m}{min}.$$

---

<sup>1</sup>From *Mathematics and the Imagination*, Simon and Schuster, 1940.

<sup>2</sup>In several of Archimedes’ great contributions we find germs of ideas that lead to the development of calculus almost two millennia later. See *Discovering the Art of Mathematics - Calculus* in this series for more information.

<sup>3</sup>Here we will ignore a few more sophisticated *cosmological* issues that complicate the discussion. While these may change the actual calculations, it is in only minor ways that do not fundamentally alter our ability to concisely quantify an upper bound for the size of the observable universe.

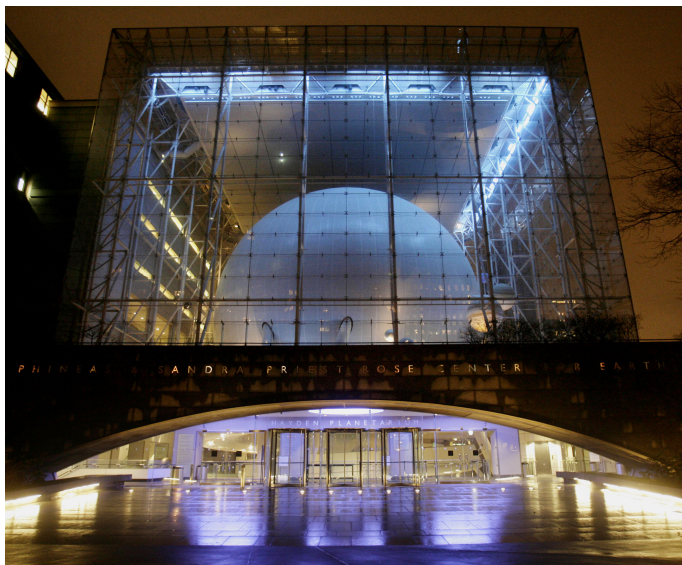

FIGURE 1. The Hayden Sphere at the American Museum of Natural History in New York City; A powerful vehicle for learning about the relative scales of things great and small. See Section 7.8 for more information.

Notice that the speed of light is now given in meters per minute. There is no reference to seconds, for these dimensions have canceled. We leave it to you (in Investigation 16) to show that in meters per second the speed of light is:

$$\text{Speed of light} \approx 9.45 \times 10^{15} \frac{m}{\text{year}}.$$

Now, if the universe expanded for 15 billion years at the speed of light, the result would be a spherical observable universe whose radius is:

$$r = (15 \times 10^9 \text{ year}) \left( 9.45 \times 10^{15} \frac{m}{\text{year}} \right) \approx 1.42 \times 10^{26} m.$$

If this observable universe has the radius calculated above, we leave it to you (in Investigation 17) to show it has a volume of:

$$V \approx 1.20 \times 10^{79} m^3.$$

How many molecules could we pack into such a volume? What we know about the distribution of matter in the universe suggests that such a volume packed with lead would safely overestimate the true number of molecules in the universe.<sup>4</sup>

So we need to figure out how many molecules there are in a cubic meter of lead. The requisite data for lead is a molecular mass of  $207 \frac{g}{\text{mole}}$  and a density of  $11.3 \frac{g}{\text{cm}^3}$ . Combined with *Avagadro's number*,  $6.022 \times 10^{23} \frac{\text{molecules}}{\text{mole}}$ , we calculate:

$$\frac{(11.3 \frac{g}{\text{cm}^3})(6.022 \times 10^{23} \frac{\text{molecules}}{\text{mole}})}{207 \frac{g}{\text{mole}}} \approx 3.29 \times 10^{22} \frac{\text{molecules}}{\text{cm}^3} = 3.29 \times 10^{28} \frac{\text{molecules}}{m^3}.$$

In other words, what this last calculation shows, is that each cubic meter of lead contains about  $3.29 \times 10^{28}$  molecules. We have about  $1.20 \times 10^{79}$  cubic meters to fill up. So if we filled up the entire observable universe we've been considering with lead, the total number of molecules would be about

$$(1.20 \times 10^{79} m^3) \left( 3.29 \times 10^{28} \frac{\text{molecules}}{m^3} \right) \approx 3.95 \times 10^{107} \text{ molecules}.$$

This is not “much more” than a googol of molecules.

<sup>4</sup>In contrast to our intuition, a cubic meter of aluminum consists of more than twenty times as many molecules as a cubic meter of lead. Can you find out why? And what is the most “molecular” element so we have an honest upper bound?

## 2. Large Numbers and Everyday Things

To get a better sense of the fairly large, let us begin with something we believe we know well: time.

In the next five problems you are asked to estimate various quantities. First reactions are what is desired, so you should make these estimates without performing any calculations.

1. Quickly estimate how long you think one thousand seconds are in a more appropriate measure of time.
2. Quickly estimate how long you think one million seconds are in a more appropriate measure of time.
3. Quickly estimate how long you think one billion seconds are in a more appropriate measure of time.
4. Quickly estimate how long you think one trillion seconds are in a more appropriate measure of time.
5. Quickly estimate the number of seconds you have been alive.
6. Precisely determine how long one thousand seconds are in a more appropriate measure of time.
7. Precisely determine how long one million seconds are in a more appropriate measure of time.
8. Precisely determine how long one billion seconds are in a more appropriate measure of time.
9. Precisely determine how long one trillion seconds are in a more appropriate measure of time.
10. What do Investigations **6-9** tell you about the relative size differences between thousands, millions, billions and trillions?
11. Compute the number of seconds in one day.
12. Compute the number of seconds in one year.
13. Use Investigation **11** and Investigation **12** to precisely determine, within a hundred thousand seconds or so, the number of seconds you have been alive.
14. How close were your estimates in Investigations **1-4** to the actual results in problems Investigations **6-9** and Investigation **13**?
15. What does your answer to problem Investigation **14** tell you about your fluency with large numbers?
16. Show that the speed of light in meters per second is, as stated in the text:

$$\text{Speed of light} \approx 9.45 \times 10^{15} \frac{m}{\text{year}}.$$

17. Show that the volume of sphere of radius  $r \approx 1.42 \times 10^{26} m$  is given by

$$V \approx 1.20 \times 10^{79} m^3.$$

Money is something else we know fairly well, for good or ill. Let us consider some examples of large sums of money.

Using newspaper reports, televised news reports, the Internet, or other source in your library if necessary, find several specific items whose costs or budgets are:

18. ... in the thousands of dollars.
19. ... in the millions of dollars.
20. ... in the billions of dollars.
21. ... in the trillions of dollars.

## 3. A Trillion Dollars in Human Terms

Here's another example of large numbers, one with obvious human implications. It was developed by **Lou Jean Fleron** (American Labor Educator; 1940 - ), mother of the first author, in the 1980's. Those with an interest in the topic should feel free to update the numbers and/or change the geographical regions to suit their purpose.

The population of several states is given in the table below:

Kansas	2,486,000
Missouri	5,138,000
Nebraska	1,585,000
Oklahoma	3,158,000
Iowa	2,787,000

You probably have friends and/or relatives who live in these states.

For each of the following questions find the desired quantities and give a single value for the entirety of these five states considered together.

22. If we consider the average family size to be 4, how many total families are there in these states?
23. What would the total cost be to build a \$100,000 house for each of the families in these states?
24. What would the total cost be to give each of the families in these states a \$15,000 car?
25. What would the total cost be to build a \$5 million library and \$15 million hospital in a total of 250 cities in these states?

- 26.** What would the total cost be to build a \$10 million school in a total of 500 cities in these states?
- 27.** If you started with \$1 trillion dollars and did all of the things described in Investigations **23-26**, how much money, if any, would be left?
- 28.** If you put the left over balance calculated in Investigation **27** in the bank and earned 3% interest per year, compounded yearly, how much interest would be earned each year? [Assume the interest is not reinvested.]
- 29.** If you used the yearly interest from Investigation **28** to pay doctors, nurses, teachers, police officers, and firefighters each \$40,000 a year salaries, how many such public servants could you hire with the interest alone?
- 30.** Using Investigation **29**, how many doctors, nurses, teachers, police officers, and firefighters would the interest provide for each of 250 different cities in these states?

All of the costs you considered in Investigations **23-29** cost less than \$1 trillion dollars. In comparison, in each of the years 2002 - 2010 the United State national debt grew at least one-half a trillion dollars. At 4:06:52 p.m. EST on 1/20/2010, as this was being typeset, the debt was \$12,325,889,768,889.98. Less than *one minute later*, the debt had grown by another \$2,499,876!<sup>5</sup>

- 31.** Find some information on the U.S. national debt currently and relate what you find to the discussion of large numbers in a brief essay of a few paragraphs.

#### 4. Innumeracy

In 1988 the book *Innumeracy: Mathematical Illiteracy and Its Consequences* by **John Allen Paulos** (American Mathematician; 1945 - ) was released. The book was widely read and widely praised, spending more than 5 months on the *New York Times* Best Seller list and rising as high as #5 on this list. Translated into a dozen languages, the book continues to be influential.

As the title suggests, *innumeracy* is a quantitative analogue of illiteracy. In other words, it is the inability to make sense of and reason with numbers and numerical quantities. Many believe that this is a serious problem in modern society. As Paulos writes:

At least part of the motivation for any book is anger, and this book is no exception. I'm distressed by a society which depends so completely on mathematics and science and yet seems so indifferent to the innumeracy and scientific illiteracy of so many of its citizens.

This short book contains hundreds of ways in which innumeracy misleads us into poor decision making in regards to personal risk, financial decisions, assessment of statistics, and interpretation of data. It is a powerful book.

Having discussed large numbers in several different contexts, it is appropriate for you to reflect on the potential implications of innumeracy. Some suggested avenues for investigation are as follows:

**32. INDEPENDENT INVESTIGATION:** Examples from *Innumeracy* - Find the book *Innumeracy* and read a few sections. Pick out an example that is particularly interesting to you. In a brief essay, describe this example and consider the implications of such innumeracy.

**33. INDEPENDENT INVESTIGATION:** Innumeracy Experiment - Survey a collection of your friends, family, and peers to see how prevalent innumeracy is. Do this by describing your work with large numbers and then telling them about the figures you found in Investigations **18-21**. However, when you report your figures, interchange some of the terms millions, billions and trillions so the figures are not correct. See what proportion of your audience catches on. Describe your results and then discuss the societal impact of a populace who generally cannot distinguish the words million, billion, and trillion when used in context.

**34. INDEPENDENT INVESTIGATION:** Original Example - Create, develop, and/or find your own example that illustrates innumeracy. Describe the example, its relevance, and its potential impact on society.

<sup>5</sup>There are a number of debt clocks online, including [http://www.brillig.com/debt\\_clock/](http://www.brillig.com/debt_clock/).



**35. INDEPENDENT INVESTIGATION:** Original Essay - Develop and answer your own essay prompt that addresses the issue of innumeracy in a way that you find compelling, important, and/or related to interests of yours.

### 5. Names of Some Really Large Numbers

This book is about the infinite. One trillion is pretty large in human terms, as we have just seen. But it is dwarfed by a googol - a number named by a kid. Do other really large numbers have names, like a “zillion” perhaps?

The majority of large number names that are commonly used, words like million, billion, and trillion, were named systematically by **Nicolas Chuquet** (French Mathematician; 1445 - 1488) circa 1484. Over time these names were extended. But the most remarkable extension came just recently when this scheme was adapted to include numbers like millinilliontrillion by **Allan Wechsler** (; - ), **John H. Conway** (British Mathematician; 1937 - ), and **Richard K. Guy** (British Mathematician; 1916 - ) in the 1990's. While these names might sound like part of a mathematical Jabberwocky<sup>6</sup>, this extension, which includes a mnemonic scheme to name *any* number no matter how large, is investigated systematically in the section ??? of the book *Discovering the Art of Mathematics - Patterns* in this series.

The table below gives you a glimpse of some of the fabulous names. Some specific numbers which had previously been named, like googol, googolplex and Skewes', can be named by their original name or their name in this scheme depending on context. Googol's name in this scheme, ten *Duotrigintillion*, does not roll off the tongue quite as nicely as googol.

Thousand	1,000	$10^3$
Million	1,000,000	$10^6$
Billion	1,000,000,000	$10^9$
Trillion	1,000,000,000,000	$10^{12}$
Quadrillion	1,000,000,000,000,000	$10^{15}$
Quintillion	1,000,000,000,000,000,000	$10^{18}$
Tredecillion	1,000, ..., 000	$10^{42}$
Googol	1, $\underbrace{000,000, \dots, 000,000}_{42 \text{ zeroes}}$	$10^{100}$
Octdecitrecentillion	1, $\underbrace{000,000,000, \dots, 000,000,000}_{100 \text{ zeroes}}$	$10^{957}$
Millinilliontrillion	1, $\underbrace{000,000,000,000, \dots, 000,000,000,000}_{957 \text{ zeroes}}$	$10^{3,000,012}$
Googolplex	1, $\underbrace{000,000,000,000,000, \dots, 000,000,000,000,000}_{3,000,012 \text{ zeroes}}$	$10^{10^{100}}$
Skewes' Number	1, $\underbrace{000,000,000,000,000,000, \dots, 000,000,000,000,000,000}_{10^{100} \text{ zeroes}}$	$10^{10^{10^{34}}}$
	$\underbrace{\hspace{15em}}_{10^{10^{34}} \text{ zeroes}}$	

FIGURE 2. Names of selected large numbers

### 6. Exponential Growth and Really Large Numbers

We'd like to construct some situations where really large numbers arise.

**36.** Take a blank sheet of 8 1/2" by 11" paper and fold it in half. Now fold it in half again. And again. See how many such folds you can make, describing what limitations you face.

<sup>6</sup>The language of the non-sense poem from *Through the Looking Glass*. It is interesting to note that Alice's creator, **Lewis Carroll** (English author; 1832 - 1898) was an amateur mathematician and logician of some note.

**6.1. Britney Gallivan and the Paper-Folding Myth.** Urban legend has it that the maximum number of times you can fold a piece of paper in half is seven. Like many things, myths become “fact” when they hit the Internet - see the PBS entry <http://pbskids.org/zoom/activities/phenom/paperfold.html>. Like many such “truths”, they are false.

In December, 2001 **Britney Gallivan** (American Student; 1985 - ) challenged this legend by analyzing paper-folding mathematically and finding limits on the number of folds based on the length,  $L$ , and thickness,  $t$ , of the material used. What she found is that in the limiting case the number of folds,  $n$ , requires a material whose minimum length is

$$L = \frac{\pi \cdot t}{6}(2^n + 4)(2^n - 1)].$$

Using this result she was able to fold paper with 11 folds and later with 12 folds.<sup>7</sup> Subsequently, Gallivan received quite a bit of notoriety: her story was mentioned in an episode of the CBS show *Numb3rs*, was included on an episode of The Discovery Channel’s *Myth Busters*, and resulted in her being invited to present the keynote address at the regional meeting of the National Council of Teachers of Mathematics in Chicago in September, 2006.



FIGURE 3. Britney Gallivan and paper folded 11 times.

37. After your first fold, how many layers thick is your folded paper?
38. After your second fold, how many layers thick is your folded paper?
39. After your third fold?
40. Continue a few more times until you see a clear pattern forming. Describe this pattern.
41. Suppose you folded your paper 20 times; how many layers thick would it be?
42. Suppose you folded your paper 30 times; how many layers thick would it be?
43. Use Investigations 37-42 to determine a *closed-term algebraic expression* for the number of layers thick your folded paper will be after  $n$  folds.
44. How tall, in an appropriate unit of measure, is a pile of paper that has as many layers as the folded paper you have described in Investigation 41? (Hint: a ream of paper, which is 500 sheets, is about  $2\frac{1}{2}$ " tall.)
45. How tall, in an appropriate unit of measure, is a pile of paper that has as many layers as the folded paper you have described in Investigation 42?
46. How many folds are necessary for the number of layers to exceed a googol? Explain.

This paper folding example illustrates what is known as *exponential growth* because a quantity grows by a fixed rate at each stage; i.e. we repeatedly multiply at each stage. We see it yields gigantic numbers. If we want, we can built fantastically larger numbers by repeatedly exponentiating at each stage.

<sup>7</sup>See <http://pomohistorical.org/12times.htm> for more information.

If we were to add the numbers below to the table in Figure 2, where would each of the following numbers go?<sup>8</sup>

47.  $10^{10}$ .

48.  $10^{10^{10}}$

49.  $10^{10^{10^{10}}}$ .

50. Is there any limit to the process described in Investigations 47-49? Explain.

51. Archimedes worked very hard to determine a way to write very large numbers. What do you think his opinion of our modern notational systems might be?

While these numbers seem so large that they are inaccessible, we can in fact learn things about them. On 23 August, 2008 a group using a *distributed computing*<sup>9</sup> program available through the Great Internet Mersenne Prime Search (GIMPS) found the largest known prime number,  $2^{43,112,609} - 1$ , which is a whopping 12,978,189 digits long. As the discoverer, GIMPS was awarded \$100,000 by the Electronic Frontier Foundation for finding the first prime number of more than 10,000,000 digits. For more about the importance of primes in industry, finance, and cryptography, as well as more about *Mersenne primes*, see [Discovering the Art of Mathematics - Number Theory](#) in this series.

52. Where does the Mersenne prime just described belong in the table of large numbers above?

## 7. Connections

**7.1. History.** Find out about some of the number systems used prior to the *Enlightenment*. Without the positional numbering system we use today *or* exponential notation, it would be tremendously hard to write “simple” large numbers like a trillion. The “larger” large numbers we have considered here would certainly be well out of reach.

53. INDEPENDENT INVESTIGATION: In a brief essay, describe the advance that our modern systems of numeration and notation made over the number systems used throughout most of the time of humans on earth. How impressive of an advance is this?

**7.2. Literature.** In his famous short story “Library of Babel” noted fiction writer **Jorge Luis Borge** (Argentine Author; 1899 - 1986) describes a library that contains every possible 410 page book which has forty lines per page and eighty spaces per line. With a few adjustments for cover lettering and other minor issues, such a library would contain about  $10^{1,834,097}$  volumes.<sup>10</sup> Significantly smaller than the largest known Mersenne prime, this library would contain

- A book of the story of your life through your current age.
- So many books whose first half contain the story of your life through the current time that every possible second half of your life would also be described by a book in the library.
- A book of the complete history of the Earth through the current time.
- A book of the story of the lives of each of your as-yet-unborn children.

Extending far beyond our spatial capabilities, we can - with Borge’s help - imagine such a library. It has finitely many volumes. And indeed, we have seen how to work with even larger numbers. We have not yet reached the infinite, even though such a library would contains volumes that describe essentially everything we might ever know.

**7.3. Biology.** *DNA*, the genetic blueprints for each living thing, can be thought of as long double chains whose links are made up of one of four different bases: A (Adenine), C (Cytosine), G (Guanine), and T (Thiamin). The length of a complete strand of human DNA is about 5,000,000 bases long. The number of different combinations of 5,000,000 base pairs chosen from the four available bases is about  $10^{3,012,048}$ .

54. INDEPENDENT INVESTIGATION: How does one determine the number of different possible length 5,000,000 DNA strand combinations? Are two different random strings of 5,000,000 base pairs equally likely to resemble a human DNA strand or are there limitations to the arrangements of the bases in

<sup>8</sup>It is important to keep the order of operations correct.  $10^{10^2} = 10^{100}$  which is much greater than  $(10^{10})^2 = (10^{10})(10^{10}) = 10^{20}$ .

<sup>9</sup>For more, see Section 7 later in this chapter.

<sup>10</sup>[The Unimaginable Mathematics of Borges’ Library of Babel](#) by William Goldbloom Block, p. 18.

humans? Since there are over  $10^{3,012,048}$  different combinations, can you begin to see why people - all 7-plus billion of us - are all so different? Explain.

**7.4. Probability. Archbishop Tillotson** (English Clergyman and Archbishop; 1630 - 1694) asked:

How often might a man, after he had jumbled a set of letters in a bag, fling them out upon the ground before they would fall into an exact poem, yea, or so much as make a good discourse in prose. And may not a little book be as easily made by chance as this great volume of the world?<sup>11</sup>

One often sees a more modern, comic rendition, a monkey sitting at a typewriter and outputting pages of Shakespeare by typing at random. In fact, one can actually quantify how long it would take for such a remarkable event to happen at random. Typing one letter per second, it would take approximately  $10^{3,000,000}$  years for Sir Arthur Conan Doyle's Hound of the Baskerville's to result in its entirety at random.<sup>12</sup>

With the advent of computers we have access to much more data and this can often be used in ways that don't honor the underlying mathematical principles of probability. For example, in 1997 **Michael Drosnin** (American Journalist; 1946 - ) wrote *The Bible Code* which purported to find a hidden code in the Hebrew bible which contains information about past and future world events. The book became a best-seller despite the efforts of many to discredit the methods it used.<sup>13</sup> Among other things, **Brendan McKay** (Australian Mathematician; 1951 - ) has published dozens of so-called "predictions" foretold in *Moby Dick* by **Hermann Melville** (American Author; 1819 - 1891), including: exact information about the death of **Diana Frances** (Princess of Wales; 1961 - 1997) as well as the assassinations of **John F. Kennedy** (American President and Politician; 1917 - 1963), **Martin Luther King, jr.** (American Clergyman and Civil Rights Leader; 1929 - 1968), and even (in the future) Drosnin himself!<sup>14</sup> Despite this outcry Drosnin published *The Bible Code II: The Countdown* to recycle this poor idea and capitalize on the great losses and fear in the aftermath of 9/11.

**7.5. Political Science.** In 1978 **Dennis Livingston** (; - ) and **Stephen Rose** (; - ) created a poster that illustrated the "social stratification in the United States" by family income level. An updated "American Profile Poster" is below in Figure 4. The poster, as shown, accounts for all families in the United States whose combined income is below \$150,000 annually. At 8 feet tall - twice the height of the original poster - one would find the last full icon representing the 190,000 people with annual income above \$300,000. Despite this, there are over 20,000 whose annual income is over \$10 million. At the scale of the poster icons representing these people would have be displayed at the top of a poster more than twenty stories high!

**55. INDEPENDENT INVESTIGATION:** Displaying Large Number Data - Find out more about Rose's American Profile Poster or how other noteworthy statisticians, graphic designers, and artists display large number data. One important candidate is **Edward Rolf Tufte** (American Statistician and Political Scientist; 1942 - ) who has written several well-known books about the display of data.

**7.6. Technology.** In distributed computing researchers employ Internet-based interfaces to coordinate software which allows them to run analysis programs on the home computers of volunteers when these computers are idle. By joining the power of thousands of computers together and recycling idle computer time at no cost, this has become a very powerful tool to help with mathematical and scientific research. This includes the search for extraterrestrial intelligence through the SETI@Home project (see <http://setiathome.ssl.berkeley.edu/>), many important biological and medical efforts (see e.g. <http://www.hyper.net/dc-howto.html>) and the search for large primes (GIMPS is at <http://www.mersenne.org/>).

<sup>11</sup>Quoted on p. 413 of *Essays on the Intellectual Powers of Man* by Thomas Reid.

<sup>12</sup>From "The Challenge of Large Numbers," by Richard E. Crandall, *Scientific American*, Feb. 1997, pp. 74-8. This article contains an interesting discussion of large numbers, large primes, and the use of modern computers in relation to large numbers.

<sup>13</sup>See, e.g. "Book Review: *The Bible Code*" by Allyn Jackson, *Notices of the American Mathematical Society*, Vol. 44, No. 8, September, 1997, pp. 935-8; "Comments on *The Bible Code*" by Shlomo Sternberg, *Notices of the American Mathematical Society*, Vol. 44, No. 8, September, 1997, pp. 938-9, with Sternberg saying Drosnin and his collaborators have, in perpetuating this "puerile nonsense", "not only brought shame on themselves, they have disgraced mathematics."; "He Who Mines Data May Strike Fool's Gold", Peter Coy, *Business Week*, 16 June, 1997.

<sup>14</sup>See <http://cs.anu.edu.au/~bdm/dilugim/diana.html> and <http://cs.anu.edu.au/~bdm/dilugim/moby.html> for details.

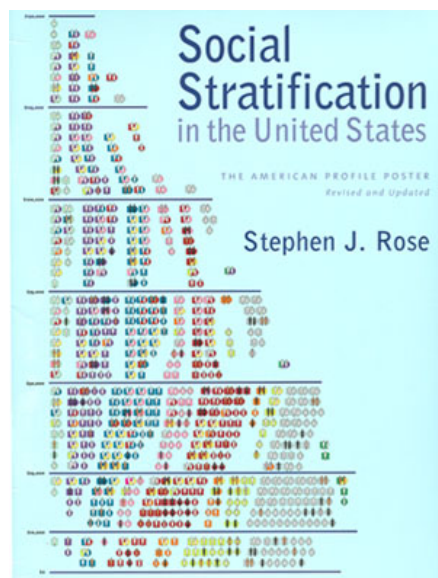

FIGURE 4. Stephen J. Rose’s “American Profile Poster”.

**7.7. Astronomy.** The book Powers of Ten was written by **Philip Morrison** (American astronomer, writer, and activist; 1915 - 2005) and **Phyllis Morrison** (American teacher and author; - 200?) [?]. It is a very powerful tour of the universe through a series of 41 brilliant pictures. Starting at  $10^{25}$  meters from Earth, each successive page is 10 times closer than the last and ends at a scale of  $10^{-16}$  meters. We see the Milky Way galaxy come into focus, followed by our solar system, Earth, Lake Shore Drive in Chicago, IL, a picnicking couple, skin cells, lymphocytes, DNA, and down past atomic nuclei. It is a tour that leaves your understanding of the scale of universe forever changed.

Powers of Ten has spawned many reinterpretations.

Earth Zoom to Washington DC<sup>15</sup> is a flip-book which provides a Powers of Ten like tour almost as a movie. Another reinterpretation is part of the wonderful photo galleries of optical microscopy at Molecular Expressions. Their “Secret Worlds: The Universe Within,” <http://micro.magnet.fsu.edu/primer/java/scienceopticsu/powersof10/>, is an interactive version of Powers of Ten available as an interactive tutorial or screensaver. “Secret Worlds: The Universe Within” runs from 10 million light years from Earth to the level of *quarks*. This is a range of  $10^{23}$  meters to  $10^{-16}$  meters.

**56. INDEPENDENT INVESTIGATION:** Both Powers of Ten and “Secret Worlds: The Universe Within” use linear measures as their scale while we live in a three-dimensional world. Describe how tours of the universe can be used to illustrate the procedure we used to find an upper bound for the number of molecules in the observable universe.

**7.8. Field Trip.** Pictured in Figure 1, the Hayden Planetarium is remarkable for its aesthetic and architectural brilliance. Its interior houses an IMax theater in the top hemisphere and a laser light emulation of the Big Bang in its lower hemisphere. Around the exterior is a spiral path which takes museum visitors on a tour of the scale of things great and small in our universe. Every 15 feet or so a scale model of an important object (cellular nucleus, red blood cell, human being, Earth, solar system, Milky Way galaxy) is compared to another important object whose relative size is equivalent to the massive Hayden sphere that rests in front of you. A few more steps and the object that was as large as the Hayden sphere is now small enough to be held in your hand while it is dwarfed by something that much bigger in scale.

In many ways it is a tactile version of Powers of Ten.

Visit if you ever have the chance.

**7.9. Children’s Literature.** Children are fascinated by large numbers. **David M. Schwartz** (children’s author; - ), with the help of a number of wonderful illustrators (Steven Kellog, Paul Miesel, and

<sup>15</sup>Available only online from Optical Toys at <http://www.opticaltoys.com/>.

Marissa Moss), has created a beautiful collection of books on large numbers including: How Much is a Million?, Millions to Measure, If You Made a Million, G is for Google: A Math Alphabet Book, and On Beyond a Million: An Amazing Math Journey.

## CHAPTER 2

### ...and Beyond

Purely mathematical inquiry in itself...lifts the human mind into closer proximity with the divine than is attainable through any other medium. Mathematics is the science of the infinite, its goal the symbolic comprehension of the infinite with human, that is finite, means.<sup>1</sup>

**Hermann Weyl** (German Mathematician; 1885 - 1955)

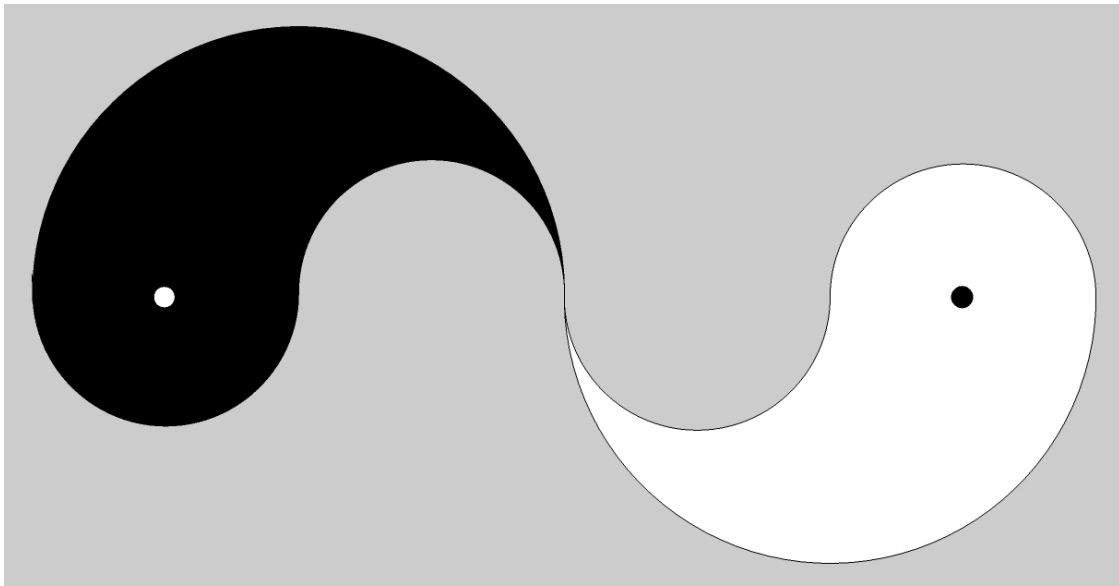

FIGURE 1. “Yinfinity” by Julian F. Fleron.

In Chapter 1 we saw examples of very large numbers. We showed that the number of molecules in the observable universe is less than  $10^{107}$ . We saw how gigantic this number was in human terms. Yet we saw that this number was simply a garden-variety large number that was quickly eclipsed by many of the truly large numbers we considered. In fact, we saw how to make massively larger numbers. These numbers are well beyond human comprehension in a meaningful physical way. Yet we name such gigantic numbers and even may hope to say something about them mathematically.

All of these numbers we considered, no matter how much they stretched the limitations of how we might describe them, are finite. Not only are they finite, they are insignificantly small in an important sense. Think of all of the *whole numbers* up to a googol. These numbers make up exactly 0% of the numbers that remain beyond it!

Do we have any real way of understanding the infinite? If you think not, you would find yourself in good company among philosophers, mathematicians and scientists through the nineteenth century.

However, things change rapidly after that, as we shall see.

Let us begin our study of the infinite in a very familiar setting, with the **natural numbers**: 1, 2, 3, .... The infinitude of this collection of numbers is natural and obvious. Even the smallest children, once they understand the central idea of counting, demonstrate their understanding of the infinitude of this set by gloating that they can always find a number bigger than any one you might pick. “Plus one,” they reply smugly.

The most commonly used symbol for the infinite is:

---

<sup>1</sup>Quoted on p. 108 [?]

$\infty$ .

This symbol was first introduced by **John Wallis** (English mathematician; 1616 - 1703) in his important Tractatus de sectionibus conicis and Arithmetica infinitorum, both appearing in 1655.<sup>2</sup> Why did he choose this symbol? Is this an appropriate symbol?

The surviving Roman numeral for 1,000 is M. However, another prominent symbol was  $\textcircled{1}$ .

1. Explain how the Roman symbol  $\textcircled{1}$  may have given rise to the symbol  $\infty$ .
2. The most commonly used Roman numeral for 500 is D. How might this symbol be related to  $\textcircled{1}$ ?
3. To make numbers larger than 1,000 additional circles were added. So  $(\textcircled{1})$  was 10,000.<sup>3</sup> What would 100,000 be? How long could this process be continued? Does this suggest a different symbol for the infinite? Explain.

**Karl Menninger** (German mathematics teacher; 1898 - 1963) tells us in his encyclopedic Number Words and Number Symbols: A Cultural History of Numbers that “at one time 100,000 was the ‘last’ number known to the Romans.”<sup>4</sup> It was denoted by  $\infty$  enclosed under a  $\square$  and the use of this notation is part of the archeological record, appearing on a tablet from A.D. 36.<sup>5</sup>

4. How does Wallis’ choice of a  $\infty$  for a symbol for the infinite relate to this historical fact?
5. Throughout history numerals used to represent numbers have often been closely related to the words used to represent the number. For example, the Roman numeral C comes from the Latin *centum* for hundred. What’s the last (lower case) character of the Greek alphabet. How is this symbol visually related to  $\infty$ . Might this have something to do with the genesis of the use of the symbol  $\infty$ ? Explain.
6. In the days of Wallis, movable type pieces - small blocks of metal with a raised letter, numeral, or figure on the top - were used in all printing presses. How might the use of the symbol  $\infty$  be related to the extant type pieces of the time?

The shape of the symbol  $\infty$  is now known as a *lemniscate*. This term comes from the Latin *lemniscus*, which means hanging ribbon. Interestingly, this term was coined, in a mathematical sense, to name an algebraic curve discovered by **Jakob Bernoulli** (Swiss mathematician; 1654 - 1705) in 1694 - almost 40 years *after* Wallis had begun using it as a symbol for the infinite. While the lemniscate is more widely known as the symbol for infinity, it has a much more important role in mathematics - part of the family of curves which helped give rise to the study of *elliptic functions*; profoundly important mathematical objects. Additionally, the lemniscate is a special type of *Cassinian oval* a family of curves which were discovered by **Giovanni Domenico Cassini** (Italian mathematician and engineer; 1625 - 1712) in 1680. So the history of this symbol is somewhat scattered.

7. What do you think of the symbol  $\infty$  for the infinite? Do you like it? Do you find it aesthetically pleasing? Does it seem to be an appropriate symbol? If not, can you think of an alternative? Explain.
8. How is the artwork in Figure 1 related to the infinity symbol? Where might the name of this art have come from?

So how does the symbol represent a “hanging ribbon”? From a sheet of paper cut two strips each about  $\frac{1}{2}$  inch wide and about 12 inches long. Bring the two ends together to form a short cylinder - a loop.

9. Tape one loop together. Take the other loop and give one end a *half twist*. Now tape the ends together. How do these figures differ from each other? Explain.
10. You’ve created what is known as a **Möbius band**.<sup>6</sup> Pick it up and hold one part of the ribbon between your thumb and forefinger. Turn it around, viewing it from several different vantage points. Can you see the infinity symbol represented?

<sup>2</sup>See e.g., Boyer’s History of Mathematics, 1968, pp. 417-8.

<sup>3</sup>Menninger, 1969, p. 245.

<sup>4</sup>1969 edition, p. 44.

<sup>5</sup>Menninger, 1969, p. 245.

<sup>6</sup>The Möbius band was invented by **August Ferdinand Möbius** (German mathematician and astronomer; 1790 - 1868). Möbius, and those that attached his name to this object, were unaware that had been independently invented, and actually described in print earlier, by **Johann Benedict Listing** (Czech mathematician; 1808 - 1882).



11. The Möbius band is actually a marvelous and surprising mathematical object.<sup>7</sup> How many “sides” do you think the Möbius band has? With a pen or a pencil, draw a stripe down the middle of the Möbius band. Continue drawing, without picking your pen or pencil up, until you have returned to your starting point. What do you notice?
12. Lay your Möbius band back down. By folding it in three places, can you make it into a triangle?
13. The universal recycling symbol shown in Figure 2. Your folded Möbius band should resemble it. Is the symbol actually identical to your band? Explain precisely.

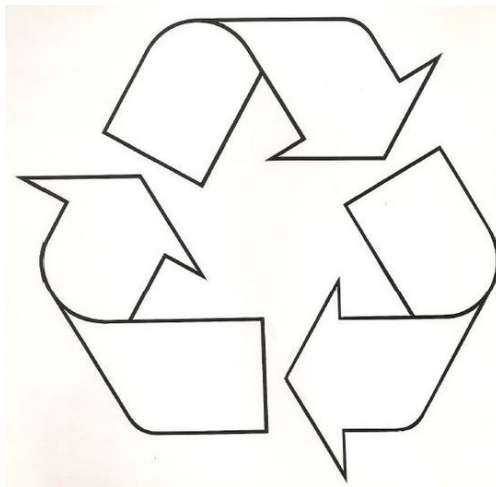

FIGURE 2. The universal recycling symbol.

## 1. Sets and Infinity

We don't want to engage in a *metaphysical* discussion about the infinite - we want a rigorous investigation. So what kinds of things are actually infinite? The infinite objects we will consider here will generally be sets which are made up of infinitely many elements.

So what is a set? And what are elements?

**Georg Cantor** (German Mathematician; 1845 - 1918), the *Father of the Infinite*, said we should think of a *set* intuitively as “a Many that allows itself to be thought of as a One.”<sup>8</sup> For example, the natural numbers  $1, 2, 3, \dots$  form the infinite set  $\mathbb{N} = \{1, 2, 3, \dots\}$ . We think of the natural numbers as one object, but of course this one object is a collection of infinitely many other objects. As you work with sets here we urge you to carefully distinguish between sets and the objects that are collected together to form these sets. The objects that are collected together to form the set are called its *elements*. You can think of the braces that contain them in the standard notation as hands that are collecting the set's elements together, holding them as a one.

To describe a set we will often list its elements. But we certainly cannot list all of the elements of an infinite set. So we will often list typical elements and then will then use the *ellipsis* “...” to denote the continued extension of these elements when the nature of their continuation should be clear.

## 2. A Set of Set Exercises

Like numbers, *functions*, and most other mathematical objects, there are many ways to perform operations on sets. One can compare them (with *inclusion* denoted by  $\subset$  and  $\subseteq$ ), combine them (with *union* denoted by  $\cup$ ), and find common elements (with *intersection* denoted by  $\cap$ ). Here we will concern ourselves with the **set difference**, denoted by  $A - B$ , where we remove elements of the set  $B$  from the set  $A$ . Specifically,

$$A - B = \{\text{All elements of } A \text{ that are not elements of } B\}.$$

14. Determine the set  $\{\diamond, \heartsuit, \clubsuit, \spadesuit\} - \{\clubsuit, \spadesuit\}$ .

<sup>7</sup>For much more, see the chapter on the Möbius band in [Discovering the Art of Mathematics - Art and Sculpture](#) in this series.

<sup>8</sup>Quoted in [?].

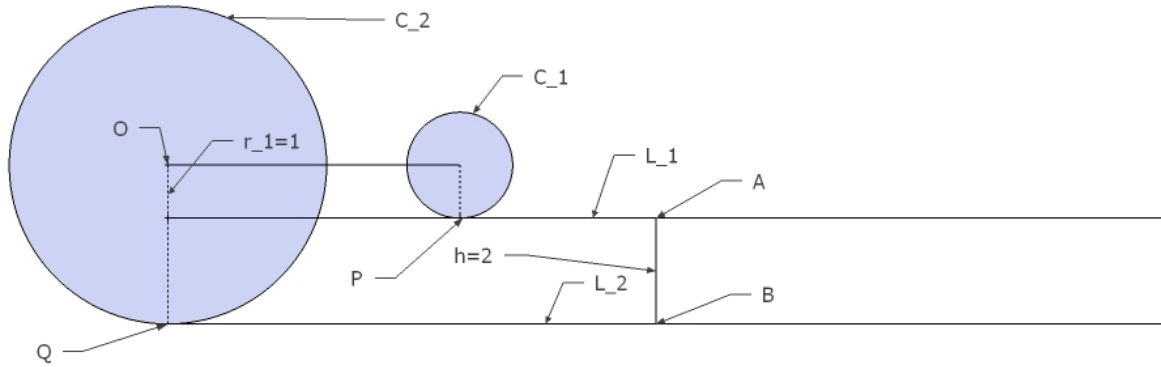

FIGURE 3. Two rolling wheels

15. Determine the set  $\{a, p, c, v, g, n\} - \{\text{Four sided shapes}\}$ .
16. Write out ten elements in the set  $\{a, b, c, \dots, x, y, z\}$  that have been left out by the ellipsis.
17. A good name for the set  $\{a, b, c, \dots, x, y, z\}$  is EnglishAlphabet. Determine the set  $\text{EnglishAlphabet} - \{a, e, i, o, u\}$ ? What is a good name for the set we have removed? For the resulting set that is left?

For finite sets the *cardinality* of the set is the number of elements in the set. For example, the cardinality of the set EnglishAlphabet is 26.

18. Determine the cardinality of each of the sets in Investigation 14, Investigation 15, and Investigation 17.

Each time we use set difference, it gives rise to statement from arithmetic. For example,

$$\text{DaysoftheWeek} - \text{Weekend} = \{\text{Monday, Tuesday, Wednesday, Thursday, Friday}\}$$

gives rise to the arithmetical statement:

$$7 - 2 = 5.$$

19. Determine the arithmetical statement that corresponds to the set difference in Investigation 14.
20. Determine the arithmetical statement that corresponds to the set difference in Investigation 15.
21. Determine the arithmetical statement that corresponds to the set difference in Investigation 17.

### 3. Infinite Arithmetic

Now let us move to the infinite. In particular, we are interested whether there is an arithmetic of the infinite that is consistent and makes sense.

22. Can you think of an appropriate value for  $\infty - \infty$  is? Explain.
23. For each of the sets  $\{1, 2, 3, \dots\}$  and  $\{4, 5, 6, \dots\}$  write out a dozen elements that have been left out by the ellipses.
24. From the infinite set  $\{1, 2, 3, \dots\}$  remove the infinite set  $\{4, 5, 6, \dots\}$ . What is the remaining set and how large is it?
25. What does Investigation 24 suggest as a value for  $\infty - \infty$ ?
26. Write out a dozen elements that have been left out of the set  $\{5, 6, 7, \dots\}$  by the ellipsis.
27. From the infinite set  $\{1, 2, 3, \dots\}$  remove the infinite set  $\{5, 6, 7, \dots\}$ . What is the remaining set and how large is it?
28. What does Investigation 27 suggest as a value for  $\infty - \infty$ ?
29. Can the investigations above be extended to suggest other values for  $\infty - \infty$ ? Explain in detail what values are suggested and/or what the limitations are.
30. Write out a dozen elements that have been left out of the set  $\{2, 4, 6, \dots\}$  by the ellipsis.
31. From the infinite set  $\{1, 2, 3, \dots\}$  remove the infinite set  $\{2, 4, 6, \dots\}$ . What is the remaining set and how large is it?
32. What does Investigation 31 suggest as a value for  $\infty - \infty$ ?
33. What do the preceding investigations suggest about our ability to discover a straightforward arithmetic for  $\infty$ ?

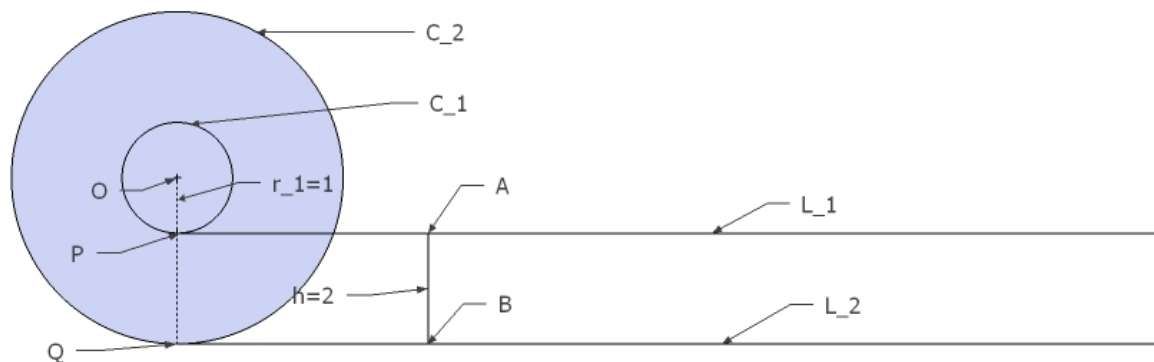

FIGURE 4. The Wheel of Aristotle

#### 4. The Wheel of Aristotle

Consider the two disks pictured in Figure 3 whose boundaries are the circles  $C_1$  and  $C_2$  and whose radii are  $r_1 = 1$  unit and  $r_2 = 3$  units respectively. Throughout, think of these as actual physical wheels which are rolling along the parallel lines  $L_1$  and  $L_2$  respectively. The points  $P$  and  $Q$  travel along the circles as they roll.

34. Draw a scale picture which represents the situation when i) the smaller wheel has been moved to the right until  $P$  and  $A$  are concurrent<sup>9</sup>, and, ii) the larger wheel has been moved to the right until  $Q$  and  $B$  are concurrent.
35. Beginning with the situation in Investigation 34, allow the smaller wheel to roll to the right through one full rotation. Draw a scale picture of the resulting situation, labelling the point where  $P$  first comes in contact again with  $L_1$  by  $C$ .
36. How long is the line segment  $\overline{AC}$ ? Explain.
37. Beginning with the situation in Investigation 34, allow the larger wheel to roll to the right through one full rotation. Draw a scale picture of the resulting situation, labeling the point where  $Q$  first comes in contact again with  $L_2$  by  $D$ .
38. How long is the line segment  $\overline{BD}$ ? Explain.

The **Wheel of Aristotle** is constructed by gluing two circular disks together with their centers concurrent. We will use the same wheels as above. Our wheel then looks as in Figure 4. The vertical line segment  $\overline{OQ}$  is simply a reference line from the center of the circles to  $L_2$ .

39. Draw a scale picture which represents the situation when the Wheel of Aristotle has been moved to the right until  $P$  and  $A$  are concurrent, and,  $Q$  and  $B$  are concurrent.

We would like to analyze the situation as the Wheel of Aristotle “rolls” along the lines  $L_1$  and  $L_2$ .

40. Beginning with the situation in Investigation 39, allow the Wheel of Aristotle to roll horizontally to the right until the first time that the line  $\overline{OQ}$  is again vertical and is in contact with  $L_2$ . Draw a scale picture of the resulting situation, labeling the point where  $P$  comes into contact with  $L_1$  by  $C$  and the point where  $Q$  again comes in contact with  $L_2$  by  $D$ .
41. When you rolled the Wheel of Aristotle in Investigation 40, how many rotations did the larger wheel undergo? Explain.
42. When you rolled the Wheel of Aristotle in Investigation 40, how many rotations did the smaller wheel undergo? Explain.
43. What is the length of the line segment  $\overline{AC}$ ?
44. What is the length of the line segment  $\overline{BD}$ ?
45. Compare your answers to Investigation 36 and Investigation 38 with Investigation 43 and Investigation 44. Describe the disagreement you see. This difficulty is often referred to as the **Wheel Paradox of Aristotle**.
46. Can you explain how and why the disagreement in Investigation 45 arises?

The apparent contradiction that arose in Investigation 45 can be explained physically. Construct a **Square Wheel of Aristotle** from paper or cardboard that mimics the construction above but uses squares instead of circles. We will keep the notation  $L_1$  and  $L_2$  from above.

<sup>9</sup>Two points are **concurrent** if they occupy the same point in space.

47. Draw a time-lapse like picture which shows how the large square travels as the Square Wheel of Aristotle undergoes one full rotation. When is the large square in contact with  $L_2$ ? How does the size of this contact area related to the size of the square?
48. Similarly, draw a time-lapse like picture which shows how the small square travels as the Square Wheel of Aristotle undergoes one full rotation. When is the small square in contact with  $L_1$ ? How does the size of this contact area related to the size of the square?
49. Is the behavior of the Square Wheel of Aristotle more understandable than the (circular) Wheel of Aristotle? Explain.
50. Could the construction and analysis carried out above be carried out if one employed wheels constructed from hexagons, octagons, dodecagons, etc.? If so, what would the results be? Describe them carefully.
51. What explanation for the apparent contradiction considered in Investigation 45 do these examples suggest? Is this a legitimate answer that explains the apparent contradiction? Explain.

There is another strange situation that the Wheel of Aristotle brings to light - one that will become essential to our study of the infinite.

52. How many points make up the circle  $C_1$ ?
53. How many points make up the circle  $C_2$ ?
54. Which do you think contains more points circle  $C_2$  or circle  $C_1$ ? How many more?  
Suppose the line segment  $OQ$  is free to rotate about the point  $O$ , like the hand of a clock.
55. As the line segment  $OQ$  rotates, how many points on  $C_1$  is it in contact with at any given time? How many points on  $C_2$  is it in contact with at any given time?
56. Can each point on  $C_2$  be “matched up” with a unique point on  $C_1$  by suitably rotating the line segment  $OQ$ ? Explain.
57. Can each point on  $C_1$  be “matched up” with a unique point on  $C_2$  by suitably rotating the line segment  $OQ$ ? Explain.
58. What do Investigations 55-57 tell you about the relative number of points on  $C_2$  as compared to the number of points on  $C_1$ ?
59. How do your answers to Investigation 54 and Investigation 58 compare? Explain in detail.

## 5. Zeno’s Paradox of Motion

A *paradox* is a statement or result that seems to be logically well founded although it is contrary to common sense or intuition. The Wheel of Aristotle involved two paradoxes, one of which you worked to resolve in Investigation 51. The other, the comparison of the number of points on the circles  $C_1$  and  $C_2$ , is at the heart of the the surprises infinity gives rise to that we wish to understand.

There are many famous paradoxes that arise in settings involving the infinite - problems that have confounded philosophers, mathematicians, scientists, writers, and thinkers for thousands of years. Two more are given here. The first is one of the famous paradoxes of the **Zeno of Elea** (Greek Philosopher; circa 490 B.C. - circa 420 B.C.).

60. When you’re done working on this chapter you might like to leave the room you’re currently working in. How far is the door from where you are sitting now?
61. Before you can reach the door to leave, you must cover half the distance to the door. How far is this?
62. However, to get halfway to the doorway, you have to cover half of that distance first, right? How far is this?
63. And before you cover the distance from Investigation 62, you must cover half of that distance first, right? How far is this distance from where you are sitting?
64. Can the reasoning in Investigation 63 be continued? For how long?
65. Before you can leave the room, every single one of the stages described in Investigation 64 must *first* be completed - all infinitely many of them. What does this seem to suggest about your ability to leave the room?
66. What do these investigations seem to tell you about any kind of motion at all?
67. Is this realistic?

This “forever trapped with my mathematics book” paradox is a version of one of Zeno’s paradoxes referred to as the *Zeno’s dichotomy*. Another of Zeno’s paradoxes is known as *Achilles and the Tortoise*. In this paradox the swift Achilles allows a tortoise a half lap lead in a one lap race.

68. As Achilles races to the halfway point, what will the tortoise be doing?
69. As Achilles races from the halfway point to the tortoise’s new location, what will the tortoise be doing?

70. In analogy to Zeno's dichotomy, show how the idea of Investigations Investigation 68 and Investigation 69 can be repeated indefinitely, suggesting that Achilles will always be behind the tortoise.
71. Does this seem realistic?
72. Investigation 66 and Investigation 70 show why these examples of Zeno's are considered paradoxes. Can you think of any way out of these paradoxes?

We will return to the Achilles and the Tortoise paradox soon.

## 6. Non-Convergence in Measure

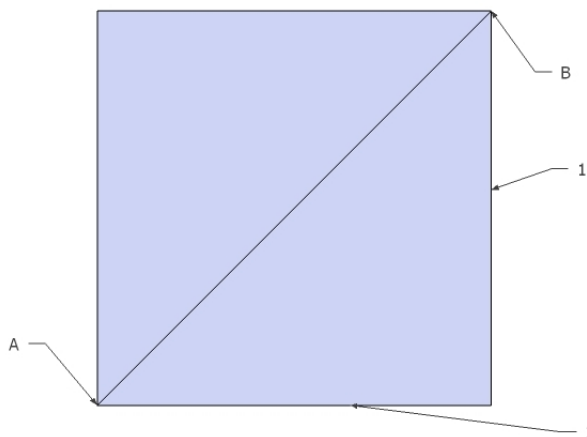

FIGURE 5. The Unit Square

Here's another paradox. Consider the square in Figure 5, each of whose sides are 1 unit long. We would like to travel from corner  $A$  to corner  $B$ .

73. Clearly the most efficient way to get from  $A$  to  $B$  is a straight line, the diagonal  $\overline{AB}$  which has been drawn in as indicated. Find the length  $L$  of this diagonal.
74. Travel from  $A$  to  $B$  by moving vertically one unit and then horizontally one unit. Does this seem to be an efficient way to travel? What is the length of this path?
75. Travel from  $A$  to  $B$  by alternatively moving vertically and then horizontally in one-half unit increments. Does this seem like it will be a more efficient way to travel? Draw in this path and find its length.
76. Travel from  $A$  to  $B$  by alternatively moving vertically and then horizontally in one-quarter unit increments. Does this seem like it will be a more efficient way to travel? Draw in this path and find its length.
77. Travel from  $A$  to  $B$  by alternatively moving vertically and then horizontally in one-eighth unit increments. Does this seem like it will be a more efficient way to travel? Draw in this path and find its length.
78. What do you notice about the lengths of the paths in Investigation 74 - Investigation 77? Will this pattern continue indefinitely?
79. As the length of the vertical and horizontal increments get smaller and smaller, how do the paths compare to the diagonal path  $\overline{AB}$ ? How do the lengths of these paths compare? Can you explain this paradox?

### CLOSING ESSAY

This chapter was an introduction to the infinite. But it was also a warning - when working with the infinite things do not always work as we would expect. Some of these examples should be disturbing. They should give you a sense of intellectual disequilibrium.

In a brief essay, describe your thoughts and feelings about the infinite as this chapter closes.

## 7. Connections

**7.1. Poetry.** The infinite appears in numerous poems. Two of our favorites are below. Note the distinction between what one can quantify and one can't in the first poem and the links to exponential growth in the second.

I amass countless numbers,  
I pile millions into a mountain,  
I pour time in a heap,  
Ranges of innumerable worlds.  
When I look at you  
From a reckless height,  
Then I see that you are Far above all numbers and measures  
They are just part of you.

**Albert von Haller** (German Doctor and Poet; 1708 - 1777)

So, naturalists observe, a flea  
Has smaller fleas that on him prey;  
And these have smaller still to bite 'em,  
And so proceed ad infinitum.

**Jonathan Swift** (; - ), author of Gulliver's Travels. This stanza is from the long poem "On Poetry: A Rhapsody" which uses the infinite explicitly in many other places as well.

**80. INDEPENDENT INVESTIGATION:** Find two or three poems in which the infinite appears. What are your thoughts on the use of the infinite in these poems?

**7.2. Art and Design.** The near universal use of the symbol  $\infty$  to represent infinity is not without its detractors. As a student working through this book, **Brianna Lyons** (American student and graphic designer; - ) was pointed in her critiques of this symbol: "If infinity starts at some point and continues forever then in its journey, it should not cross over itself, like the lemniscate does in the middle." Her "defiance and need to be different" lead her to create an alternative symbol, shown in Figure 6. She says that this new symbol "puts my mind at ease, accurately representing infinity thru two seemingly endless spirals."

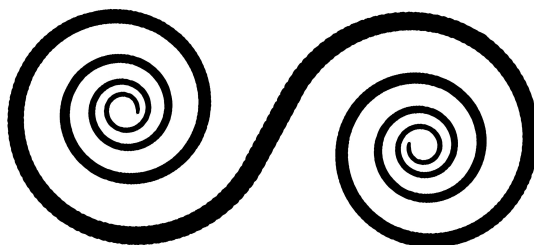

FIGURE 6. Alternative infinity symbol by Brianna Lyons.

**81. INDEPENDENT INVESTIGATION:** Consider the relative merits of the alternative symbol for the infinity in Figure 6 in comparison to the typical symbol. Can you think of another alternative symbol? What properties should it have? Are there limitations or properties an alternative symbol must have to be widely used? Explain.

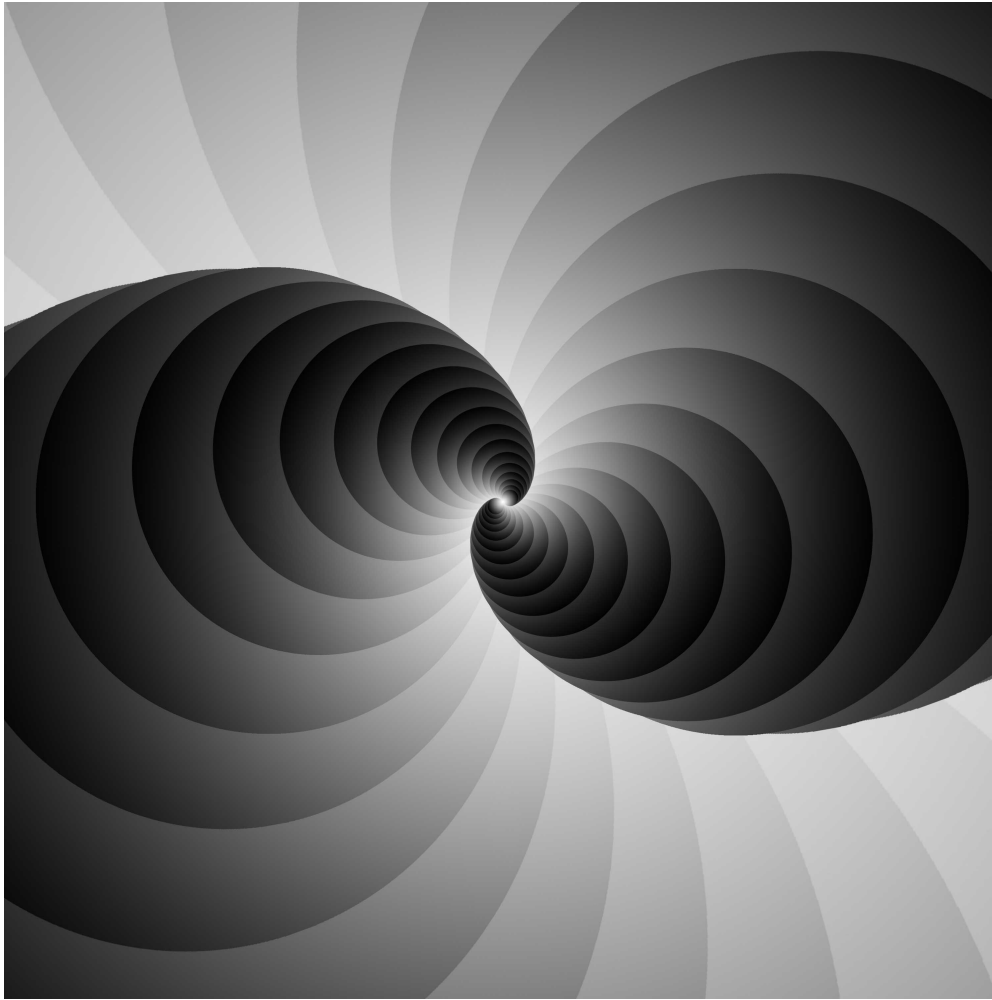

FIGURE 7. Towers by Brianna Lyons.

**82. INDEPENDENT INVESTIGATION:** Where do you see the infinite represented in Figure 7? How is it related to other artwork or symbols in this book or that you have seen elsewhere in relation to the infinite. How do you think this image was created?

**83. INDEPENDENT INVESTIGATION:** Where do you see the infinite represented in Figure 8? How is it related to other artwork or symbols in this book or that you have seen elsewhere in relation to the infinite. How do you think this image was created? Look at a high-resolution, color version of tunnels. (Available online at ???) What is the impact of the colored dots? Why does this happen? Do the names of these pieces of artwork seem appropriate? Explain.

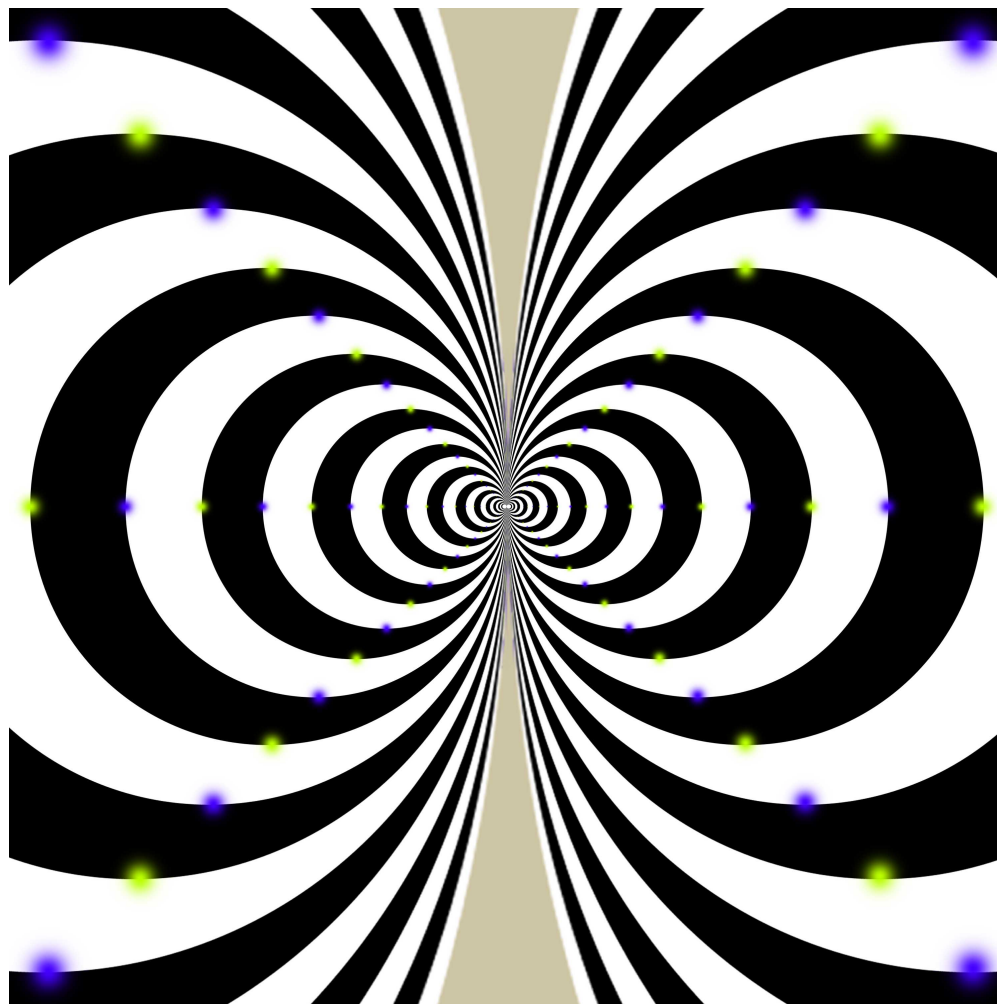

FIGURE 8. Tunnels by Brianna Lyons.



## Grasping Infinity

Our minds are finite, and yet even in these circumstances of finitude we are surrounded by possibilities that are infinite, and the purpose of life is to grasp as much as we can out of that infinitude.

**Alfred North Whitehead** (English Mathematician and Philosopher; 1861 - 1947)

To many the infinite is a mysterious, troubling, metaphysical notion. The paradoxes in the previous chapter may have reinforced these views, suggesting there is little hope of grasping the infinite in any meaningful way. If you feel this way you are not alone - through history this view has been widely held.

Yet for many the infinite has served as the ultimate puzzle, the supreme challenge. A select group of nineteenth century mathematicians rose to this challenge and helped us put this puzzle together.

After exploring some of this trailblazing work, we shall see that despite being finite beings with finite experiences, we can both understand and use the infinite in meaningful, logical, and mathematically rigorous ways.

There will be surprises, but this should be expected. After all, we are dealing with the infinite, something beyond all of our finite experiences. If infinite objects behaved exactly as finite objects there would be little to be interested in.

FOCUSSING QUESTION - 0.999...

What can we say about the infinitely repeating decimal 0.999...?

Think about the focussing question a bit. Talk with some peers about this question. Make some conjectures. Write down some questions about 0.999... that it may be important to answer. See what progress you can make in understanding this infinite mathematical object.

### 1. Algebra and Infinitely Repeated Decimals

With the the warning above in mind, let us proceed using “simple” algebra and arithmetic to analyze the infinitely repeated decimal  $0.121212\dots$ <sup>1</sup> We’re not sure what this number is. Often we denote an unknown quantity by a variable so we are free to work with it. So define this quantity by the variable  $x$ , i.e.

$$x = 0.121212\dots$$

Multiplying both sides of this equation by 100 yields

$$100x = 12.1212\dots$$

This seems to have accomplished little more than creating another number,  $10x$ , with the same unpleasant infinite string of decimal digits. However, employed creatively, this *scaling* can help us.

Consider the following difference:

$$\begin{array}{r} 100x = 12.121212\dots \\ -x = 0.121212\dots \\ \hline \end{array}$$

Think about carrying out this subtraction. All of the decimal digits on the right, all infinitely many of them, cancel out those on the left leaving only the number 12 as a result. But the left hand side is a simple algebraic expression, leaving, upon subtraction,  $99x$ . So the difference, once simplified, becomes

$$99x = 12.$$

Solving for  $x$  we see that  $x = \frac{12}{99}$ , i.e.  $0.121212\dots = \frac{12}{99}$ . If you want, you can check this on your calculator for some reassurance.

What have we done? We have converted an infinite object into a finite one, a simple fraction.

<sup>1</sup>The notation  $0.\overline{12}$  is often used instead of  $0.121212\dots$ . We will employ the latter notion because the ellipsis  $\dots$  can be used in many different settings involving the infinite.

## 2. 0.999... and 1

1. Describe any thoughts, ideas, questions, and/or conjectures that you made about 0.999... when you thought about the Focussing Question at the outset of this chapter.
2. Define  $x = 0.999\dots$ . Scale this number by a factor of 10. That is, determine the value of  $10x$ .
3. Can you adapt the method used above to with 0.121212... to determine an alternative, non-decimal identity for 0.999...? Explain.
4. Is your result in Investigation 3 intuitively satisfying to you? Explain.

The result in Investigation 3 is often surprising to people. So let's investigate the number 0.999... in an alternative way.

5. What is the exact value of  $\frac{1}{3}$  as a decimal?
6. Check the previous result using long division to precisely write  $\frac{1}{3}$  as a (possibly infinite) decimal. Express your result as an equation:  $\frac{1}{3} = \boxed{\phantom{000}}$ .
7. Multiply both sides of your equation from Investigation 6 by 3. What non-decimal identity does this suggest for the number 0.999...?
8. Does this additional analysis help your intuition?

### WARNING ABOUT CALCULATORS -

Here and below you should *only* use calculators to check finite calculations. As you have just seen the number 0.333... is an infinite process as a decimal, but a finite one as a fraction. Calculators are generally decimal based. This illustration is part of a more general principle - computers cannot deal with infinite processes, but the human mind can.

## 3. More Infinite Decimals

9. Consider the the number represented by the infinitely repeated decimal  $x = 0.373737\dots$ . Scale this number by a factor of 10; i.e. compute  $10x$ . Does this scaling help you to employ the method used above with 0.121212... to determine an alternative, non-decimal identity for 0.373737...? Explain.
10. Compute  $100x$ . Does this scaling allow you to employ the method above to determine an alternative, non-decimal identity for 0.373737...? Explain.
11. Now consider the infinitely repeated decimal number  $x = 0.295295295\dots$ . Compute  $10x$ . Does this scaling help you to employ the method used above to determine an alternative, non-decimal identity for 0.295295295...? Explain.
12. Compute  $100x$ . Does this scaling allow you to employ the method above to determine an alternative, non-decimal identity for 0.295295295...? Explain.
13. Determine an alternative, non-decimal identity for 0.295295295...
14. Yet another infinitely repeated decimal number is 0.821982198219... Find an alternative, non-decimal identity for this number.
15. Repeat Investigation 14 for the infinitely repeated decimal  $x = 0.123456123456123456\dots$
16. Repeat Investigation 14 for the infinitely repeated decimal  $x = 0.123456789123456789123456789\dots$
17. These examples should suggest a general method, or *algorithm*, for determining alternative, non-decimal identities of *any* infinitely repeating decimal numbers. Explain.

## 4. Another Infinite Objects

The infinite decimal 0.121212... is infinite only in the sense that it has infinitely many decimal digits. As we have seen, it is really just a garden variety fraction,  $\frac{12}{99}$ . So 0.121212... does not represent an infinite quantity, rather an object whose description is infinite. Mathematics is full of "infinite objects" that are not infinite in the sense that they are unlimited or without bound, but only in the sense that they are comprised of infinitely many pieces or created as the result of some infinite process.

Another example is the *infinite series* which is formed by adding infinitely many terms together. A "simple" example of an infinite series is

$$1 + \frac{1}{2} + \frac{1}{4} + \frac{1}{8} + \dots$$

Here the ellipsis means that the terms in this series continue indefinitely, following the evident pattern.

What does one do with a series? Series involve adding. It is natural to look for the *sum*.

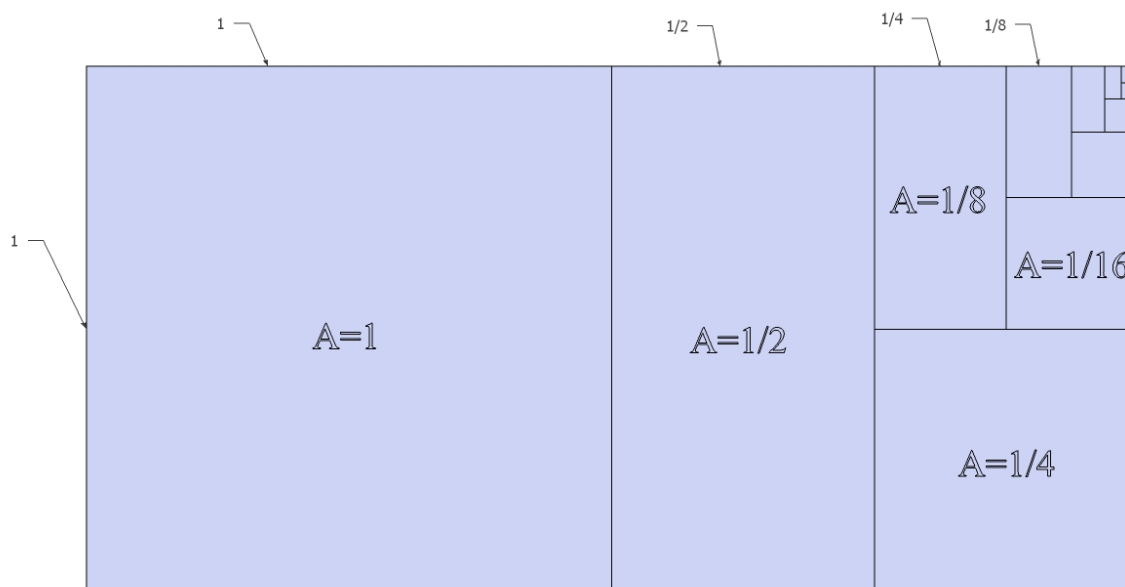

FIGURE 1. Bounding the infinite series  $1 + \frac{1}{2} + \frac{1}{4} + \frac{1}{8} + \dots$

What is the sum of an infinite series? One's intuition might suggest that because this sum grows as each successive term is added it would grow without bound. That is, the series would be infinite not simply in the number of terms added, but that the sum of this series must be infinite as well.

Such intuition is wrong. We shall see that Figure 1 shows in a straightforward, geometric way that the sum of the infinite series  $1 + \frac{1}{2} + \frac{1}{4} + \frac{1}{8} + \dots$  can be computed *and* it is finite.

### 5. Infinite Objects - Numerically

Let's return to  $0.999\dots$  for a moment and think about it numerically, considering the numbers as numbers on the number line.

18. Which number is closer to 1, 0.9 or  $0.999\dots$ ? Explain.
19. What is the distance between 1 and 0.9?
20. Which number is closer to 1, 0.99 or  $0.999\dots$ ? Explain
21. What is the distance between 1 and 0.99?
22. Which number is closer to 1, 0.999 or  $0.999\dots$ ? Explain
23. What is the distance between 1 and 0.999?
24. You should see a pattern forming. Describe this pattern precisely.
25. So how close to 1 is  $0.999\dots$ ? Can you conclude anything from this? Explain.

What about infinite series?

26. What are the next ten terms following  $\frac{1}{8}$  in the series  $1 + \frac{1}{2} + \frac{1}{4} + \frac{1}{8} + \dots$ ?
27. Write the sum of the first two terms in the infinite series  $1 + \frac{1}{2} + \frac{1}{4} + \frac{1}{8} + \dots$ , i.e.  $1 + \frac{1}{2}$ , as a single fraction.
28. Repeat Investigation 27 for the first three terms.
29. Repeat Investigation 27 for the first five terms.
30. Repeat Investigation 27 for the first nine terms.
31. Do you see a pattern in your answers?
32. Use this pattern to predict the sum of the first 15 terms.
33. Do these calculations suggest a exact value for the sum of this infinite series? Explain.

At this point some people protest, "All this shows is that the one object gets closer and closer to another, getting infinitely close together. This doesn't have to mean they are the same." This is a legitimate objection. But we remind you, as you saw in the Student Toolbox, while mathematics may develop inductively, in response to our experiences and intuition, its foundation starts with definitions and then it is built logically on top of the definitions. To answer the objection, we need to have an agreed upon definition of the numbers

we are using: fractions, decimals, and even infinitely repeating decimals. These numbers are part of the *real numbers* which comprise the number line that you have drawn since elementary school.

Two millenia of investigations into the properties of the real numbers, with investigations like those you have completed above, have shown mathematicians that the most useful definition of the real numbers is as the unique *complete, Archimidean, ordered field* containing all of the fractions. The adjective **complete** means little more than when two real numbers are “infinitely close” to each other they must be the same real number.

- 34.** Does this historical context provide you some closure or fulfillment on issues such as the identity of  $0.999\dots$ ? Explain.

In every field it is important to make working definitions that enable discussion and investigation. What is ADD? How do we classify a certain genus of plants? What do we mean by reasonable doubt in a court of law?

- 35.** Find a total of a half dozen examples of definitions, terms, or concepts from a few different fields that have changed over time. Describe them and their nature of change.

The pioneering work of several mathematicians, particularly **Augustin Louis Cauchy** (French Mathematician; 1789 - 1857) and **Karl Weierstrass** (German Mathematician; 1815 - 1897), during the mid-to late-nineteenth century in a period which has become known as the *Age of Analysis*, was responsible for the definitions of the real numbers. While other numbers systems may arise and find practical use, e.g. the *surreal numbers* you shall soon see, the real numbers will retain a central place in mathematics and the theorems that have been proven about them will remain unchanged.

As real numbers in this system  $0.999\dots = 1$  and  $1 + \frac{1}{2} + \frac{1}{4} + \frac{1}{8} + \dots = 2$ .

For information on where to learn more about some of these issues, see the conclusion of Section Section 8 below.

## 6. Infinite Objects - Algebraically

Another way to try to determine the sum of an infinite series is to proceed algebraically as we did above. Namely, we would like a way to scale our infinite series so we could compare it to the original in a way leads only to finite objects that we can analyze in the standard way.

Consider again the sum

$$S = 1 + \frac{1}{2} + \frac{1}{4} + \frac{1}{8} + \dots$$

The key insight to scaling this infinite object is that each term in this series is a factor of  $\frac{1}{2}$  as large as the one that precedes it.

- 36.** Scale  $S$  by a factor of  $\frac{1}{2}$ ; i.e. write  $\frac{1}{2}S$  as an infinite series.  
**37.** Compare  $S$  and  $\frac{1}{2}S$ . Is it possible to adapt the method we used with decimals so all but finitely many terms can be canceled? Explain.  
**38.** Determine an exact value for  $S$ . How does it compare with your answer in Investigation **33**?

Consider now the infinite series  $1 + \frac{1}{3} + \frac{1}{9} + \frac{1}{27} + \dots$

- 39.** What are the next ten terms in this series?  
**40.** Use a calculator to determine the value of the sum of the first 10 terms in this infinite series. Does this calculation suggest a value for the sum of this infinite series?  
**41.**  $\frac{1}{3}$  plays a critical role in relationship between consecutive terms in this infinite series. What role is this?

Denote the sum of this new series by  $S = 1 + \frac{1}{3} + \frac{1}{9} + \frac{1}{27} + \dots$

- 42.** Scale  $S$  by  $\frac{1}{3}$ ; i.e. write  $\frac{1}{3}S$  as an infinite series.  
**43.** Compare  $S$  and  $\frac{1}{3}S$ .  
**44.** Determine a value for  $S$ . How does your answer compare with your answer in Investigation Investigation **40**?

## 7. Infinite Objects - Geometrically

**7.1. Summing**  $1 + \frac{1}{2} + \frac{1}{4} + \frac{1}{8} + \frac{1}{16} + \dots$  Figure 1 shows a large rectangle, running from the left of the image to the right, which has been decomposed into infinitely many squares and rectangles.

- 45.** What are the dimensions and the area of this large rectangle?  
**46.** Several of the rectangles and squares have their areas labelled. What are the dimensions and areas of the two largest rectangles that have not be labelled?  
**47.** What are the dimensions and areas of the two largest squares that have not been labelled?

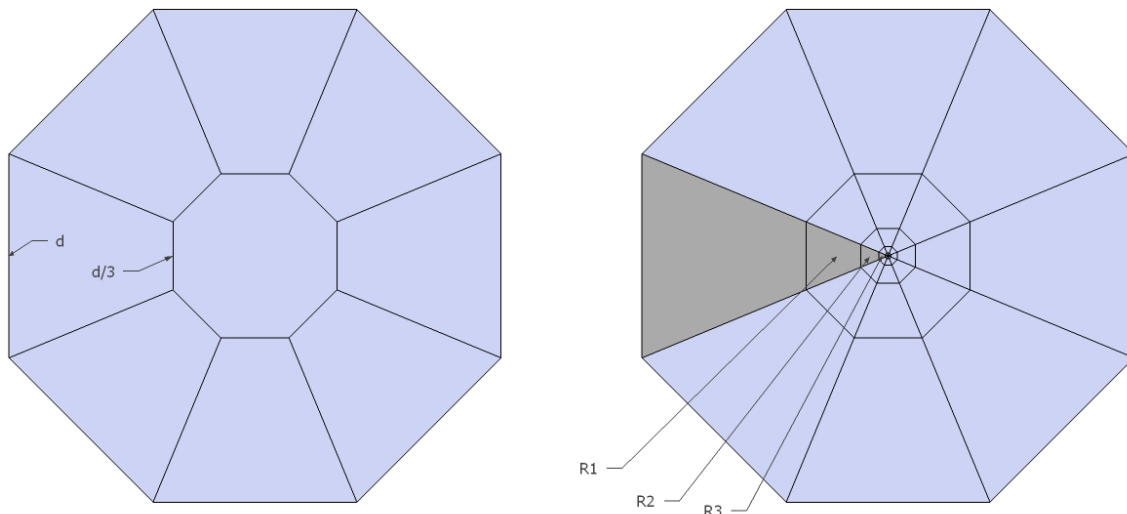

FIGURE 2. Finding the sum of the infinite series  $\frac{1}{9} + \frac{1}{9^2} + \frac{1}{9^3} + \frac{1}{9^4} + \dots$

48. On a copy of Figure 1 shade in an area equal to  $1 + \frac{1}{2}$ .
49. On a copy of Figure 1 shade in an area equal to  $1 + \frac{1}{2} + \frac{1}{4}$ . Show how this sum, computed in Investigation 28, can be geometrically visualized; i.e. how can you see both numerator and denominator using your figure?
50. On a copy of Figure 1 shade in an area equal to  $1 + \frac{1}{2} + \frac{1}{4} + \frac{1}{8} + \frac{1}{16}$ . Show how this sum, computed in Investigation 29, can be geometrically visualized; i.e. how do you see both numerator and denominator using your figure?
51. If you were asked to shade an area equal to  $1 + \frac{1}{2} + \frac{1}{4} + \frac{1}{8} + \frac{1}{16} + \dots$ , what would you shade?
52. Establish the sum of the infinite series  $1 + \frac{1}{2} + \frac{1}{4} + \frac{1}{8} + \frac{1}{16} \dots$  geometrically.

Your explorations to determine the sum of the infinite series  $1 + \frac{1}{2} + \frac{1}{4} + \frac{1}{8} + \frac{1}{16} \dots + \dots$  make up what is generally called a **proof without words**. There are many beautiful proofs without words that help establish the sum of infinite series. The investigations below consider one that is a bit harder, but is particularly nice because it works not just for one infinite series but infinitely many.

**7.2. Geometric Scaling.** The left image in Figure 2<sup>2</sup> shows a *regular* octagon which has been decomposed into trapezoids and a scaled octagon in the center. The area of the large octagon is 1 square unit and the length of the sides is represented by  $d$ . (It turns out that  $d = \frac{1}{\sqrt{2(1+\sqrt{2})}}$ , but this is unimportant.) The smaller octagon has been scaled down by a factor of  $\frac{1}{3}$ .

Scaling has been an important tool in our analysis of the infinite. It is here too. We need to discover what happens to areas when the objects that have been measured are scaled up or down.<sup>3</sup>

53. Draw several planar geometric figures whose areas you can readily find. Label their dimensions and find their areas.
54. Scale down each of the regions Investigation 53 by a factor of  $r = \frac{1}{3}$ . Draw the resulting figures and label their new dimensions.
55. Find the area of each of the scaled regions in Investigation 54. How are the areas of the scaled regions related to the areas of the original, unscaled regions?
56. Now scale up the regions in Investigation 53 by a factor of  $r = 2$ . Draw the resulting figures and label their new dimensions.

<sup>2</sup>From “Proof without words: Geometric series formula” by James Tanton in ???, vol. 39, #2, March, 2008, p. 106.

<sup>3</sup>What we will find is a special case of a more general principle that is a fundamental result from geometry. The relationship between scaling and lengths, areas, or volumes gives rise to *fractals*. For more information see [Discovering the Art of Geometry](#) in this series.

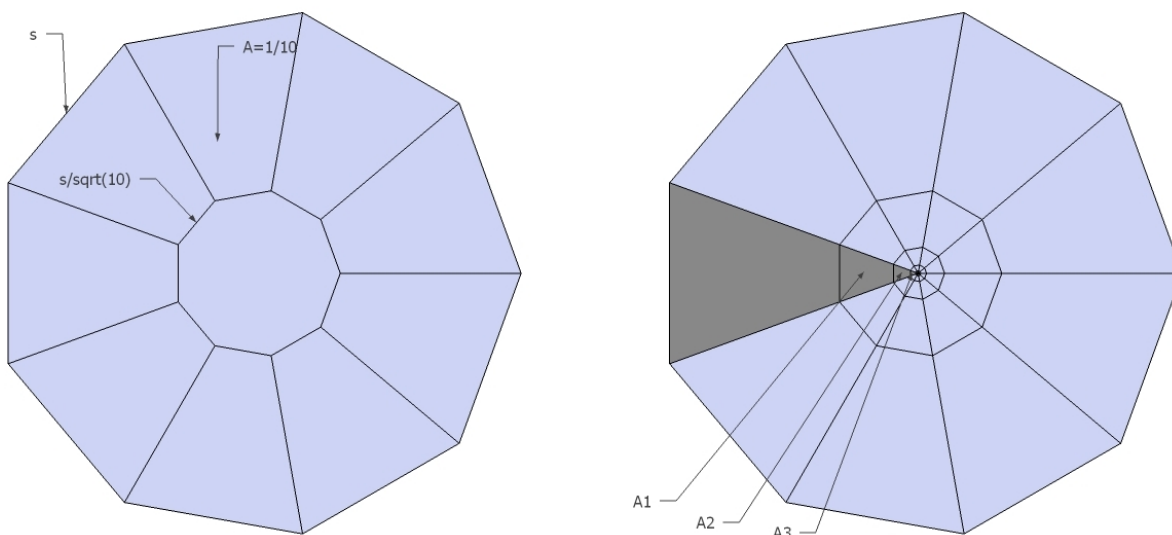

FIGURE 3. Finding the sum of the infinite series  $\frac{1}{10} + \frac{1}{10^2} + \frac{1}{10^3} + \frac{1}{10^4} + \dots$

57. Find the area of each of the scaled regions in Investigation 56. How are the areas of the scaled regions related to the areas of the original, unscaled regions?
58. There is a general relationship between the areas of planar regions and the areas of these regions once they have been scaled. Use your examples above to complete the statement of this relationship:

THEOREM 1. *Let  $R$  be a region in the plane whose area is  $A$ . If  $R$  is scaled by a factor of  $m$  then the area of the scaled region is   $\times A$ .*

**7.3. Summing**  $\frac{1}{9} + \frac{1}{9^2} + \frac{1}{9^3} + \frac{1}{9^4} + \dots$

59. What is the area of the octagon at the center of the figure on the left in Figure 2?
60. Determine the area of each of the quadrilaterals in the figure on the left in Figure 2.
- The octagon on the right in Figure 2 is congruent to the octagon on the left. It has been decomposed indefinitely, the lengths of the sides of the *nested* octagons being  $d, \frac{d}{3}, \frac{d}{9}, \frac{d}{27}, \dots$
61. Determine the area of the region which is labelled  $R_2$ .
62. Determine the area of the region which is labelled  $R_3$ .
63. Determine the area of the region which is labelled  $R_4$ .
64. You should see a pattern in Investigations 61-63. Will this pattern continue indefinitely? Explain how you know this.
65. On the right figure in Figure 2 a single triangle has been shaded. How does the area of this triangle compare to the area of the entire octagon? Explain.
66. Explain how Investigations 59-64 allow you to determine the sum of the infinite series  $\frac{1}{9} + \frac{1}{9^2} + \frac{1}{9^3} + \frac{1}{9^4} + \dots$  as a single fraction.

**7.4. 0.999... Again.**

67. Using the shapes in Figure 3 and your method in Investigations Investigations 59-66, determine the sum of the infinite series  $\frac{1}{10} + \frac{1}{10^2} + \frac{1}{10^3} + \frac{1}{10^4} + \dots$  as a single fraction.
68. Convert each of the individual terms in the series  $\frac{1}{10} + \frac{1}{10^2} + \frac{1}{10^3} + \frac{1}{10^4} + \dots$  to decimals.
69. How hard is it to determine the sum of the infinite series  $\frac{1}{10} + \frac{1}{10^2} + \frac{1}{10^3} + \frac{1}{10^4} + \dots$  as a decimal?
70. You now have determined the value of the sum of the infinite series  $\frac{1}{10} + \frac{1}{10^2} + \frac{1}{10^3} + \frac{1}{10^4} + \dots$  as a fraction and as a decimal. Multiply both by 9. What does this tell you about the identity of 0.999...?

It is a curious thing that people on the whole do not boggle over an infinite decimal of this kind (1.11111111...), but when they look at an infinite addition like this:

$$1 + 1/10 + 1/100 + 1/1000 + 1/10000 + \dots \textit{ad infinitum},$$

although this is just another way of writing the other. But I am not surprised at their looking aghast at the latter, though rather surprised that they accept the former.<sup>4</sup>

<sup>4</sup>From Playing with Infinity: Mathematical Explorations and Excursions, p. 104.

Rosza Peter (; -)

71. Are you “boggled” or “aghast” about  $0.999\dots$ ? Describe which approach is most compelling or what is still lacking in your ability to understand  $0.999\dots$

**7.5. The Sum of a Geometric Series.** We conclude the Investigations by *generalizing* the results on infinite series above.

72. In Investigation **66** and Investigation **67** you determined the sums of the infinite series  $\frac{1}{9} + \frac{1}{9^2} + \frac{1}{9^3} + \frac{1}{9^4} + \dots$  and  $\frac{1}{10} + \frac{1}{10^2} + \frac{1}{10^3} + \frac{1}{10^4} + \dots$ . Do you think that this geometric method can be used to determine the sum  $\frac{1}{5} + \frac{1}{5^2} + \frac{1}{5^3} + \frac{1}{5^4} + \dots$ ? If so, what do you think the sum will be?
73. What about  $\frac{1}{8} + \frac{1}{8^2} + \frac{1}{8^3} + \frac{1}{8^4} + \dots$ ?
74. What about  $\frac{1}{37} + \frac{1}{37^2} + \frac{1}{37^3} + \frac{1}{37^4} + \dots$ ?
75. We hope that you see a pattern. Complete the following:

**THEOREM 2.** For any positive whole number the infinite series  $\frac{1}{k} + \frac{1}{k^2} + \frac{1}{k^3} + \frac{1}{k^4} + \dots$  converges. Moreover, its sum is given by  $\frac{1}{k} + \frac{1}{k^2} + \frac{1}{k^3} + \frac{1}{k^4} + \dots = \boxed{\phantom{0000}}$ .

76. Explain how you can “see” this result geometrically.
77. Below it will be useful if our infinite series began with the term  $1+$ . Adapt the theorem just stated to find a sum of these series - simplifying the sum as much as you can:

**THEOREM 3.** For any positive whole number the infinite series  $\frac{1}{k} + \frac{1}{k^2} + \frac{1}{k^3} + \frac{1}{k^4} + \dots$  converges. Moreover, its sum is given by  $1 + \frac{1}{k} + \frac{1}{k^2} + \frac{1}{k^3} + \frac{1}{k^4} + \dots = \boxed{\phantom{0000}}$ .

Let  $r$  denote some arbitrary number. The infinite series  $1 + r + r^2 + r^3 + \dots$  is called a **geometric series**.

78. Up to the missing  $1+$ , which you know how to take care of as in Investigation **86**, explain why each of the infinite series you have considered above are geometric series by finding an appropriate value of  $r$  for each.
79. How are consecutive terms in a geometric series related to one another?
80. What do you notice about all of the values of  $r$  in Investigation **78**?
81. For certain values of  $r$  it should be clear that the sum of the associated geometric series is infinite. For example,  $1 + 1 + 1^2 + 1^3 = \dots = 1 + 1 + 1 + 1 + \dots = \infty$ . Find several other values of  $r$  for which the geometric series clearly *diverges* to  $\infty$ ?
82. In contrast, for what values of  $r$  does it seem possible that the sum of the geometric series is finite? Explain.
- 83. Classroom Discussion:** Compare results in Investigation **81** and Investigation **82**. Together can you form a conjecture that describes precisely what values of  $r$  will result in a geometric series which diverges and what values of  $r$  will result in a geometric series that converges to a finite sum?

As before, let us denote the sum of the geometric series by  $S$ ; i.e.

$$S = 1 + r + r^2 + r^3 + \dots$$

84. Scale the geometric series by a factor of  $r$ ; i.e. write  $r \cdot S$  as an infinite series.
85. Compare  $S$  and  $r \cdot S$ . Use the methods employed in the Investigations above to cancel all but finitely many terms in these infinite series.
86. Solve the equation resulting from Investigation **85** for  $S$  in terms of  $r$ .
87. Check your sum in Investigation **38** by fixing an appropriate value of  $r$  and employing your result in Investigation **86**.
88. Check your sum in Investigation **44** by fixing an appropriate value of  $r$  and employing your result in Investigation **86**.
89. Check your sum in Investigation **66** by fixing an appropriate value of  $r$  and employing your result in Investigation **86**.
90. Check your sum in Investigation **67** by fixing an appropriate value of  $r$  and employing your result in 86.

## 8. A Caveat on the Infinite

In parallel to the end of Section 5 one might object that we have treated our infinite objects as though they behaved in the same way that finite objects do - perhaps a dangerous precedent.

This is a legitimate worry.

Instead of an infinite decimal or infinite series, what if we used our algebraic methods on a whole number with infinitely many digits? How about something like  $x = \dots 999$ ? Notice the decimal point after the digit 9 in the ones place.

91. How big is the number  $\dots 999$ ? Explain.
92. Denote  $x = \dots 999$ . Scale  $x$  by a factor of 10; i.e. find  $10x$ .
93. Which is bigger,  $x$  or  $10x$ ? Does this make sense intuitively?
94. Compare  $10x$  and  $x$ . Then adapt the methods used above to determine a finite value for  $x$ . (Hint: There are two ways to perform the subtraction. Let Investigation 93 suggest which is most appropriate.)
95. Does your result in the previous Investigation make much intuitive sense? Explain.
96. Using the normal rules of arithmetic, describe how the following calculations have been completed:

$$\dots 999. + 1 = \dots 000. \quad 2 \times \dots 999. = \dots 998. = \dots 999. - 1.$$

97. Expressed using our variable  $x$  the calculations in the previous problem can be written algebraically as follows:

$$x + 1 = 0 \quad 2x = x - 1.$$

Solve these equations for  $x$ . How do your answers compare to those in Investigation 94?

The examples in this section were discovered by **Anna Mills** (American Student; 1975 - ) when she was a *seventh grade* student! She discovered these things after her teacher showed her how to consider  $0.999\dots$  algebraically much as we did above. The mounting evidence that  $\dots 999. = -1$  in some strange way led Anna, her father, and later **Paul Fjelstad** (American Mathematician; 1929 - ) to a deeper analysis. It turns out that this bizarre result makes perfect sense when considered in the worlds of *modular arithmetic* and *p-adic numbers*. This discovery resulted in the publication of “The repeating integer paradox” in *The College Mathematics Journal*, vol. 26, no. 1, January 1995, pp. 11-15. Pretty heedy stuff for a seventh grader, huh?

So what does this say about our worry about treating infinite objects in such a cavalier way? Well, it is warranted. But all of the Investigations here can be completed suitably without concern because all of the infinite objects *converge absolutely*. Like completeness mentioned in Section Section 5, this is a deep property that was central to the historical developments in the Age of Analysis.

A more technical foray into the properties, construction and history of the real numbers is generally a fundamental part of courses with names such as “Introduction to Real Analysis” which are offered to junior and senior level mathematics majors. Those interested in pursuing this topic at a less advanced level are invited to consider related topics in Discovering the Art of the Calculus in this series.



## Rigor and Divergence

The fear of infinity is a form of myopia that destroys the possibility of seeing the actual infinite, even though it in its highest form has created and sustains us, and in its secondary transfinite forms occurs all around us and even inhabits our minds.

**Georg Cantor** (German Mathematician; -)

Since human beings have never encountered actually infinite collections of things in our material existence, all of our attempts to deal with them must involve projecting our finite experience... Therefore, we must rely on logical reasoning... and then be prepared to accept the consequences of our reasoning, regardless of whether or not they conform to our intuitive feelings.

**William P. Berlinghoff** (; -)

**Kerry E. Grant** (; -)

In the later part of the Chapter 3 you developed a formula for the sum of a geometric series. Namely, the sum is given by

$$(1) \quad 1 + r + r^2 + r^3 + \dots = \frac{1}{1 - r}.$$

Let's reflect on this for a moment. In Investigations **87-90** in the previous chapter you used this formula to easily determine the sum of four series that previously we had worked fairly hard to compute. Indeed, the sum of *every* geometric series with  $-1 < r < 1$  can be computed easily this way. This is a powerful result.

- 1. Classroom Discussion:** It is somewhat typical in mathematics classes for students to be “given” a formula to “apply” to “exercises.” Having worked to determine how to deal with a number of different infinite processes and, as part of this, how to determine the sum of an infinite geometric series, you have rediscovered important mathematical results. How does your rediscovery compare with previous experiences you have had in mathematics classes? Was it better to rediscover or would you rather have had us just “give” you this formula to “use?” Explain.

Below you will see how we can use our results on geometric series to help us analyze Zeno's Achilles paradox.

Such success with the infinite is encouraging. Mathematicians of the seventeenth and eighteenth century were buoyed with similar success. The newly discovered calculus, which relied heavily on the notion of the *infinitesimal*, or infinitely small, and infinite series allowed mathematicians (who were usually scientists as well) to make remarkable progress in the description of the physical universe.

However, as indicated at the end of the previous chapter, there is an important need for rigor. Significant problems associated with the cavalier treatment of the infinite began to be noticed at the outset of the nineteenth century. **David Bressoud** (American Mathematician; -) ascribes the precipitating event to manuscript “Theory of the propagation of heat in solid bodies” by **Jean Baptiste Joseph Fourier** (French Physicist and Mathematician; 1768 - 1830). Bressoud describes the crisis as follows:

The crisis struck four days before Christmas 1807. The edifice of calculus was shaken to its foundations. The nineteenth century would see ever expanding investigations into the assumptions of the calculus, an inspection and refitting of the structure from the footings to the pinnacle, so thorough a reconstruction that the calculus would be given a new name: *analysis*. Few of those who witnessed the incident of 1807 would have recognized mathematics as it stood 100 years later.<sup>1</sup>

Below you will investigate some of the resulting rigor that was introduced in this revolution. There are a number of troubling paradoxes that remain. But these are now results of the limits of our intuition regarding the infinite, not limits of our understanding of the mathematics surrounding the infinite.

---

<sup>1</sup>From A Radical Approach to Real Analysis, p. 1.

### 1. Zeno Redux

As in the Chapter 2 we will assume Zeno’s hypothetical is 100 meters and that Achilles allows the Tortoise a 50 meter lead. When the race started, Achilles needed to reach the 50m point where Tortoise started. When he reached that point, Tortoise had moved further ahead. We can think of this as the first stage of the race. In the second stage Achilles needed to reach Tortoise’s new location. When he reached that point Tortoise again had moved further ahead. These stages continue indefinitely, suggesting that Achilles can never catch Tortoise. This is the paradox.

This is a qualitative analysis. We would like to use what we have learned about series to provide a quantitative analysis. Because this paradox involves both distance and time, speed must be involved. So let us assume that Achilles runs the race at a constant speed of 10 m/sec and Tortoise crawls at a constant speed of 4 m/sec.

2. How long does it take for Achilles to reach the point where Tortoise started the race?
3. Since the beginning gun which started the race, how much time has elapsed?
4. When Achilles reaches the starting point of Tortoise, how much further ahead has Tortoise moved?
5. At this point, how far is Tortoise from the start?
6. How long does it take for Achilles to go from Tortoise’s starting location to Tortoise’s location at the end of Stage 1 that you found in Investigation 5?
7. Since the beginning gun which started the race, how much time has elapsed?
8. When Achilles reaches the Tortoise’s location at the end of Stage 1, how much further ahead has Tortoise moved?
9. At this point, how far is Tortoise from the start?

We need to continue to identify the times and locations involved in the motions of our two racers. One way to do this is with a table.

Stage	Time Interval	Total Elapsed Time	Distance Covered by Tortoise	Tortoise Location	Distance Covered by Achilles	Achilles Location
0	0	0	0	50	0	0
1					50	50
2						

10. Use your data from Investigations 2-9 to fill in the rows for the first and second stages.
11. Now determine data which enables you to complete the table for stages 3 - 10. Describe any patterns that you see.

You should notice that both the total elapsed time and the locations of our two runners seem to be *converging* to fixed *limits* as the stage number  $n \rightarrow \infty$ . We would like to determine what these limits are.

12. Using your data, roughly estimate the limits as  $n \rightarrow \infty$  of the total elapsed time, Tortoise’s Location, and Achilles’ Location.
13. Write the limit of the Total Elapsed Time as the sum of an infinite series.
14. Use what you have learned about infinite series to determine the sum of this infinite series. Does this limit agree with your estimate above?
15. Write the limit of Tortoise’s location as the sum of an infinite series.
16. Use what you have learned about infinite series to determine the sum of this infinite series. Does this limit agree with your estimate above?
17. Check that your previous answer makes sense by using the time in Investigation 13 and the constant rate of speed Tortoise travels.
18. Write the limit of the Achilles’s location as the sum of an infinite series.
19. Use what you have learned about infinite series to determine the sum of this infinite series. Does this limit agree with your estimate above?
20. Check that your previous answer makes sense by using the time in Investigation 13 and the constant rate of speed Achilles travels.
21. Based on these investigations, what happens at the time in Investigation 13?

22. What happens after the time in Investigation 13?

Another useful way to envision Zeno's Achilles paradox is to consider it graphically.

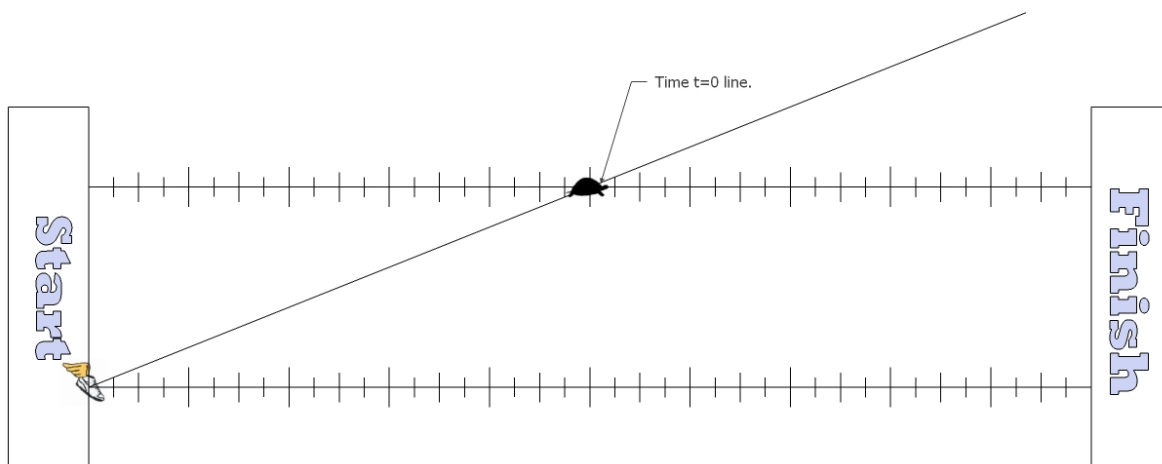

FIGURE 1. Zeno's race between Achilles and Tortoise.

23. An enlarged image of Figure 1 is included in the Appendix. On it, plot the location of Achilles and Tortoise at the end of stages 1 - 6. Keep each racer in their own lane. As has been done for time  $t = 0$ , draw a line from Achilles' location extending well through Tortoise's location.
24. What do you notice about all of the lines that you have drawn?
25. Your completed figure should now remind you of a *perspective drawing*. It may also remind you of Investigation 58 from the chapter which includes our analysis of the Wheel of Aristotle. Does this figure shed any additional light on Zeno's Achilles paradox? Explain.

In 1901 **Bertrand Russell** (English mathematician, logician, and philosopher; - ) remarked:

Zeno was concerned with three problems...These are the problem of the infinitesimal, the infinite, and continuity...From his to our own day, the finest intellects of each generation in turn attacked these problems, but achieved broadly speaking, nothing...Weierstrass, Dedekind, and Cantor,...have completely solved them. Their solutions...are so clear as to leave no longer the slightest doubt or difficulty. This achievement is probably the greatest of which the age can boast...The problem of the infinitesimal was solved by Weierstrass, the solution of the other two was begun by Dedekind and definitely accomplished by Cantor.

Nonetheless, dissenters remain. In a September, 1994 *Scientific American* feature "Resolving Zeno's Paradoxes", **William I. McLaughlin** (; - ) stated:

At last, using a formulation of calculus that was developed in just the past decade or so, it is possible to resolve Zeno's paradoxes. The resolution depends on the concept of infinitesimals, known since ancient times but until recently viewed by many thinkers with skepticism.

At last? What does this mean?

26. INDEPENDENT INVESTIGATION: Interview a mathematicians and report on her/his view of the status of legitimate mathematical solutions to Zeno's paradoxes.

An issue that further complicates Zeno's paradoxes is the distinction between idealized, mathematical models of time and space on the one hand and the real time and space we inhabit on the other. Idealized time and space are continuous and infinitely divisible. However, in prevailing physical theories matter is neither continuous not infinitely divisible. That suggests to some that real space and time are not either.

**27. INDEPENDENT INVESTIGATION:** Interview a mathematician, philosopher, and/or physical scientist and report on her/his views on the status of legitimate, real world solutions to Zeno's paradoxes.

## 2. Divergent Series

As authors we have been very careful to include only infinite series that are *well-behaved*. What this means must now be determined, but, up to this point, all of the infinite series, except those in final section about Anna Mills' . . . 999.0, we have considered are *absolutely convergent*.

We now work to clarify what it means for infinite series to be well-behaved. This is an absolutely critical matter, as realized by the famous, but tragically short-lived,<sup>2</sup> **Neils Henrik Abel** (Norwegian Mathematician; 1802 - 1829):

If you disregard the simplest cases, there is in all of mathematics not a single infinite series whose sum has been rigorously determined. In other words, the most important parts of mathematics stand without a foundation.

- 28.** Consider the sequence  $(-1), (-1)^2, (-1)^3, (-1)^4, \dots$ . Simplify the terms in this sequence so the sequence can be written without using exponents.
- 29.** Let  $r = -1$ . With the help of the ideas in the previous investigation, express the geometric series  $1 + r + r^2 + r^3 + \dots$  without the use of exponents.

The infinite series in Investigation **29** is called the **Grandi series** after **Guido Grandi** (Italian Mathematician and Jesuit Philosopher; 1671 - 1742).

- 30.** What do you think the sum of the Grandi series is? Explain.
- 31.** Using parentheses, group the first two terms in the series together, the next two terms together, the next two terms after that together, etc. What value does this suggest the sum of the Grandi series will be?
- 32.** Suppose now that you left the first term by itself and instead used parentheses to group the second and third terms together, the fourth and fifth terms together, etc. What value does this suggest the sum of the Grandi series will be?
- 33.** Are your results in Investigations Investigation **31** and Investigation **32** compatible? Explain.
- 34.** The situation in Investigation **33** was described by Grandi as "comparable to the mysteries of Christianity... paralleling the creation of the world out of nothing." What do you think of Grandi's description?
- 35.** Because the Grandi series arose from a geometric series it seems reasonable to use our formula above to ascertain a value for the sum of the series. What value does the formula predict?
- 36. Classroom Discussion:** What do these results suggest about the numbers  $0, \frac{1}{2}$ , and  $1$ ? Is any of this reasonable? What do you think is an appropriate value for the sum of the Grandi series?

Even the most gifted mathematicians were troubled by paradoxes like the Grandi series. **Leonard Euler** (Swiss Mathematician; 1707 - 1783), one of the greatest mathematicians of all times, held firmly to the conviction that  $1/2$  was the proper sum of the Grandi series.

The contemporary practice is to name infinite series for which an appropriate sum cannot be found as a *divergent series*.

A very important infinite series whose sum can be rigorously determined is called the **harmonic series**. It is the following infinite series:

$$1 + \frac{1}{2} + \frac{1}{3} + \frac{1}{4} + \dots$$

- 37.** Write out the first fifteen terms in the harmonic series.
- 38.** Sum the first three terms in the harmonic series.
- 39.** Sum the first seven terms in the harmonic series.
- 40.** Sum the first fifteen terms in the harmonic series.
- 41.** How fast does the sum appear to be growing as you add more terms.
- 42.** Is it clear whether the series will sum to a specific value? If so, what is this value?

---

<sup>2</sup>Abel made brilliant and insightful contributions to modern mathematics, but, sadly, died of tuberculosis at the age of 27. He is a revered figure in Norway and the Abel Prize is one of the more significant awards in the field of mathematics.

Consider now the infinite series

$$(2) \quad 1 + \frac{1}{2} + \frac{1}{4} + \frac{1}{4} + \frac{1}{8} + \frac{1}{8} + \frac{1}{8} + \frac{1}{8} + \frac{1}{16} + \dots$$

43. How many terms of  $\frac{1}{2}$  are there?
44. What is the sum of these " $\frac{1}{2}$  terms"?
45. How many terms of  $\frac{1}{4}$  are there?
46. What is the sum of these " $\frac{1}{4}$  terms"?
47. How many terms of  $\frac{1}{8}$  are there?
48. What is the sum of these " $\frac{1}{8}$  terms"?
49. Do the preceding problems suggest how many terms of  $\frac{1}{16}$  there will be in this series. How many?
50. What is the sum of these " $\frac{1}{16}$  terms"?
51. If we sum this series through the end of the " $\frac{1}{4}$  terms", what will the sum be?
52. If we sum this series through the end of the " $\frac{1}{8}$  terms", what will the sum be?
53. If we sum this series through the end of the " $\frac{1}{16}$  terms", what will the sum be?
54. If we sum this series through the end of the " $\frac{1}{32}$  terms", what will the sum be?
55. The sum of this series is greater than 10. Through what terms would we have to add to reach a sum greater than 10?
56. The sum of this series is greater than 100. Through what terms would we have to add to reach a sum greater than 10?
57. The sum of this series is greater than 1,000,000. Through what terms would we have to add to reach a sum greater than 10?
58. Compare the first term of the harmonic series with the first term of this new series. Then compare the second terms of these series. And the third. And the fourth. Whenever they are not equal, which series has the larger terms?
59. **Classroom Discussion:** Explain how to use the Investigations above to determine precise sums for both the series in (2) and the harmonic series.

In addition to its use for series like the Grandi series, mathematicians also call series whose sums approach  $\pm\infty$  *divergent series*.

The proof of the divergence of the harmonic series you just completed is due to **Nicole Oresme** (French Philosopher, Theologian, Mathematician, and Astronomer; c. 1323 - 1382).

### 3. Devilish Series

The divergent series are the invention of the devil, and it is a shame to base on them any demonstration whatsoever. By using them, one may draw any conclusion he pleases and that is why these series have produced so many fallacies and so many paradoxes.

**Neils Henrik Abel** (Norwegian Mathematician; 1802 - 1829)

There is no reason that infinite series must have all positive terms. For example, the **alternating harmonic series** is built from the harmonic series but with every other term negative:

$$1 - \frac{1}{2} + \frac{1}{3} - \frac{1}{4} + \frac{1}{5} - \dots$$

Shown in Figure 2 are the results of adding a small number of terms of this series. For each of the following, sum the indicated number of terms and then graph the *partial sums* on the graph provided in the appendix:

60. ... the first four terms.
61. ... the first five terms.
62. ... the first six terms.
63. ... the first seven terms.
64. ... the first eight terms.
65. ... the first nine terms.
66. ... the first ten terms.
67. ... the first eleven terms.
68. ... the first twelve terms.

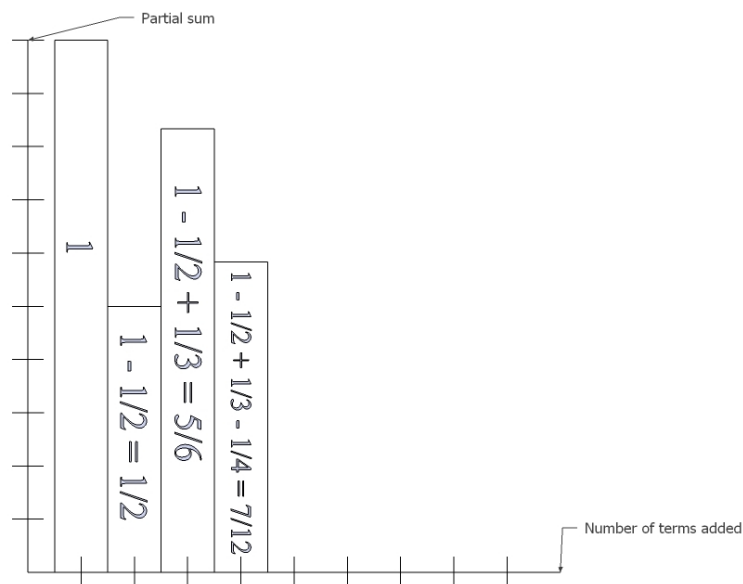

FIGURE 2. Partial sums of the alternating harmonic series.

Some of you might have access to technology (e.g. graphing calculators, programming languages, or spreadsheets) that will enable you to easily add dozens, hundreds, thousands, or even millions of terms. Here are a few examples, each correct to 20 decimal places:

Partial Series	Partial Sum
$1 - \frac{1}{2} + \frac{1}{3} - \dots - \frac{1}{100}$	0.68817217931019520324
$1 - \frac{1}{2} + \frac{1}{3} - \dots - \frac{1}{500}$	0.69214818055794532542
$1 - \frac{1}{2} + \frac{1}{3} - \dots - \frac{1}{1000}$	0.69264743055982030967
$1 - \frac{1}{2} + \frac{1}{3} - \dots - \frac{1}{5000}$	0.69304719055994510942

**69. Classroom Discussion:** Do the patterns in your partial sums allow you to determine whether a partial sum over- or under-estimates the actual sum? Can you determine a bound on how much your partial sums over- and under-estimate the actual sum? How can these observations be combined with your data to find the sum of the alternating harmonic series correct to many decimal places? Do so.

The *natural logarithm* is one of the more important functions in mathematics. Its values can be approximated on most calculators - you use the *ln* function button. The value of  $\ln(2)$ , correct to 9 decimal places, is 0.6931471806. That this is the sum of the alternating harmonic series was discovered in ?? by ??.

- 70. Is  $2 + 3 = 3 + 2$ ? Why?
- 71. Is  $219 + 3, 427 + 5, 392 = 5, 392 + 219 + 3, 427$ ? Why?
- 72. Is  $12 + 3, 492 + 12, 987 + 438 + 29, 351 + 423 = 438 + 12 + 423 + 12, 987 + 29, 351 + 3, 492$ ? Why?
- 73. Does the sum of finitely many terms remain the same when the order of the terms are rearranged?
- 74. Do you think the sum of infinitely many terms remains the same when the order of the terms are rearranged?

When we rearrange the order in which we add terms in a series, finite or infinite, we call this a **re-arrangement** - no surprise there. Let us investigate what happens when we rearrange the alternating harmonic series.

75. What would the terms in the next three sets of parenthesis in the series

$$1 - \frac{1}{2} + \left( \frac{1}{3} - \frac{1}{4} - \frac{1}{6} \right) + \left( \frac{1}{5} - \frac{1}{8} - \frac{1}{10} \right) + \dots$$

be?

- 76. Explain why the infinite series in Investigation 75 is a rearrangement of the alternating harmonic series.
- 77. Simplify and reduce the terms in each of the five sets of parenthesis in Investigation 75, leaving your results as fractions.
- 78. Show that each of the results in Investigation 77 is given by  $\frac{-1}{4n(2n+1)}$  for appropriate values of  $n$ . (Note: With a little algebra, this result can be proved to continue indefinitely.)

**79.** What can you conclude about the sum of the infinite series in Investigation **75**? Does this result agree with the sum of the series prior to its rearrangement?

Consider now the infinite series

$$1 + \left(-\frac{1}{2} + \frac{1}{3} + \frac{1}{5}\right) + \left(-\frac{1}{4} + \frac{1}{7} + \frac{1}{9}\right) + \dots$$

- 80.** What would the terms in the next three sets of parenthesis in this series be?  
**81.** Explain why this infinite series is a rearrangement of the alternating harmonic series.  
**82.** Simplify and reduce the terms in each of the five sets of parenthesis, leaving your results as fractions.  
**83.** Show that each of the results is given by  $\frac{-1}{2n(4n-1)(4n+1)}$ .  
**84.** What can you conclude about the sum of this infinite series? Does this result agree with the sum of the series prior to its rearrangement?

We have now shown that the alternating harmonic series has *three different sums* when it is rearranged! These are not fictitious sums like those of the Grandi series. These are real sums whose exact values can be rigorously determined. And this shock is just the beginning. For the alternating harmonic series can be rearranged to have *any* sum! This is the striking result of **Georg Friedrich Bernhard Riemann** (German mathematician; 1826 - 1866):

**THEOREM 4.** (*Riemann's Rearrangement Theorem*) Suppose that an infinite series of both positive and negative terms converges while the series formed by making all of the original series' terms positive diverges. (Such a series is called **conditionally convergent**.) Let  $T$  be any real number,  $+\infty$  or  $-\infty$ . Then there is a rearrangement of the series that converges to  $T$ .

This is a remarkable theorem which highlights the limits of our finite intuitions in dealing with the infinite. Unlike some of the earlier surprises and paradoxes, we are not seeing the faults in our reasoning. We've illustrated this result with rigor, the theorem itself is established deductively in a fairly straightforward way (see Further Investigations), and we must accept this result as a wonderful glimpse into the world of the infinite.

#### 4. Gabriel's Wedding Cake

In this section we see another glimpse into this magical world of the infinite. It too will require a shift in our intuition.

To analyze this example we must first visit another famous infinite series:

$$\frac{1}{1} + \frac{1}{4} + \frac{1}{9} + \frac{1}{16} + \dots$$

- 85.** Write out the next ten terms in this infinite series.  
**86.** What is the sum of the first five terms in this series?  
**87.** What is the sum the first ten terms in this series?  
**88.** Show that your answers to the previous problems are close to  $\frac{\pi^2}{6}$ .

Showing, in 1734, that the sum of the infinite series  $\frac{1}{1} + \frac{1}{4} + \frac{1}{9} + \frac{1}{16} + \dots$  is precisely equal to  $\frac{\pi^2}{6}$  was one of the great early triumphs of **Leonard Euler** (; -), one of the three greatest mathematicians of all time. It is also interesting to note that over 200 years later the sums of many closely related infinite series remain unknown. In fact, we do not know the sums of any of the *p-series* with odd exponents greater than one:

$$\begin{aligned} &\frac{1}{1^3} + \frac{1}{2^3} + \frac{1}{3^3} + \frac{1}{4^3} + \dots \\ &\frac{1}{1^5} + \frac{1}{2^5} + \frac{1}{3^5} + \frac{1}{4^5} + \dots \\ &\frac{1}{1^7} + \frac{1}{2^7} + \frac{1}{3^7} + \frac{1}{4^7} + \dots \\ &\vdots \end{aligned}$$

Indeed, these sums are values of the *Riemann Zeta Function* which is the centerpiece of the *Riemann Hypothesis*. This unsolved problem is so important there is a \$1,000,000 (US) prize for its solution as part of the Clay Mathematics Institute *Millenium Prize Problems* and it is the focus of many new books for general audiences. Links to this problem are considered in both of the volumes Discovering the Art of Mathematics: Number Theory and Discovering the Art of Mathematics: Patterns in this series.

The object in Figure 3 is called *Gabriel's Horn*. It was invented by **Evangelista Toricelli** (Italian Mathematician and Physicist; -) in 1641 and had important links to the forthcoming invention of the

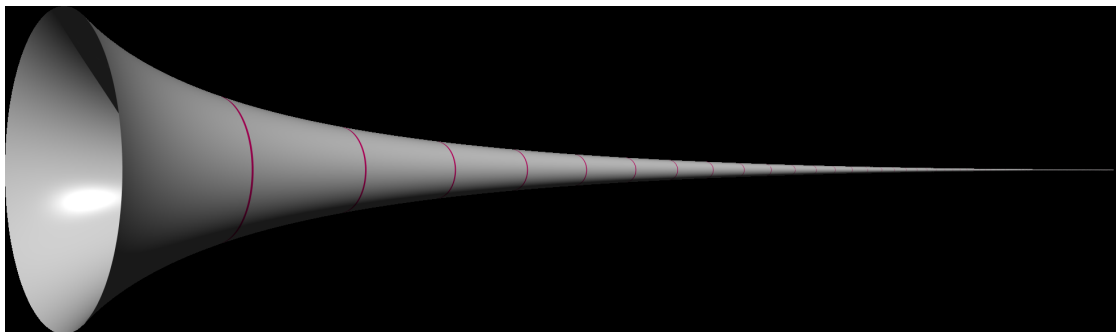

FIGURE 3. Gabriel's Horn.

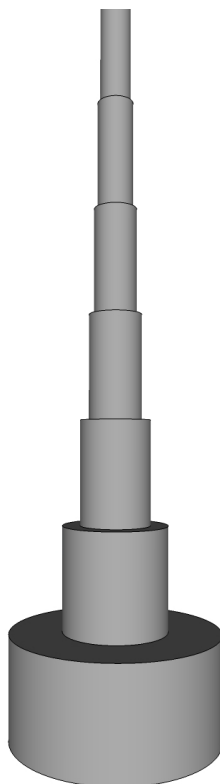

FIGURE 4. Gabriel's Wedding Cake.

calculus and sparked significant philosophical debates.<sup>3</sup> The object in Figure 4 shares similarly surprising properties as Gabriel's Horn. It was invented by **Julian F. Fleron** (American Mathematician and Teacher; 1966 - ) in 1998 and is called Gabriel's Wedding Cake.

**Gabriel's Wedding Cake** is constructed by piling an infinite number of cylindrical cake layers on top of one another. The height of each of these layers is one while the radii of these layers are  $1, \frac{1}{2}, \frac{1}{3}, \dots$ , respectively.

**89. Classroom Discussion:** Can the volume and surface area of Gabriel's Horn and Wedding Cake be measured? Do you have predictions about the size of these measures?

**90.** Describe the formulae for the volume and surface area of a cylinder.

Find an expression, leaving  $\pi$  as a symbolic value without converting it to a decimal value, for the volume of ...

**91.** ... the first layer of the cake.

<sup>3</sup>See "Gabriel's Wedding Cake" by Julian F. Fleron, *The College Mathematics Journal*, Vol. 30, No. 1, January 1999, pp. 35 - 38 for more details and references.



92. ... the second layer of the cake.
93. ... the third layer of the cake.
94. Describe the pattern you see in the measures of the volumes in the previous investigations. Use it to determine expressions for the volumes of the next four layers of the cake.
95. Determine an infinite series that measures the volume of the entire cake.
96. Using a series that we have previously considered, find the exact volume of the cake.
97. Find the total exposed area of the tops of the cakes. (Hint: it's easy if you think about all of them together, otherwise it is hard.)

Find an expression, leaving  $\pi$  as a symbolic value without converting it to a decimal value, for the surface area of the side of...

98. ... the first layer of the cake.
99. ... the second layer of the cake.
100. ... the third layer of the cake.
101. Describe the pattern you see in the measures of the surface areas in the previous investigations. Use it to determine expressions for the surface areas of the next four layers of the cake.
102. Use the previous investigation to determine an infinite series that represents the volume of the entire cake.
103. Using a series that we have previously considered, find the exact surface area of the cake.
104. **Classroom Discussion:** These investigations *prove* that the Gabriel's Wedding Cake has a volume of just over 5 cubic units while it has an infinite surface area. Does this seem feasible? If we had a single cake pan to make this cake we could make the batter to fill it, but could we grease the surface of the pan (so the cake didn't stick)? This seems problematic, doesn't it? Are there ways out of this dilemma? What does this do to our understanding of the infinite?

## 5. Connections

**5.1. Diversity.** By now you probably noticed that the overwhelming majority of our historical links have been to Eurocentric mathematicians. This parallels history in many areas. How much this has to do with the existing historical record versus issues of power, class, and race can be debated. In our particular context, progress is being made in uncovering powerful work of non-Eurocentric mathematicians. For example, many of the important results on representations of functions by *power series* seem to have been developed by Indian mathematicians of the Kerala region centuries before their European counterparts. In fact, some suggest that these results may have been carried back to Europe by Jesuit missionaries. To learn more one can begin with chapter "Indian Mathematics: The Classical Period and After" in The Crest of the Peacock: Non-European Roots of Mathematics by George Cheverghese Joseph and then look online for more recent discoveries.

**5.2. Philosophy and Religion.** In the introduction to Gabriel's Horn and Gabriel's Wedding Cake we used the word "invented". Do you think this is an appropriate word or do you think "discovered" would have been better? Those who believe "discovered" is a better word are generally called *Platonists*. Those who believe the more appropriate word is "invented" cannot be classified as easily, they may be *empiricists*, *constructivists*, *formalists*, etc. Indeed, the connections between mathematics and philosophy are deep and long-standing. Those with interest in pursuing more are encouraged to consult the chapter "From Certainty to Fallibility" in The Mathematical Experience by Philip J. Davis and Reuben Hersh which won the 1983 National Book Award in the Science category.

In the new book Naming Infinity Loren Graham and Jean-Michel Kantor describe how

Name Worshipping - a religious viewpoint regarded as heresy by the Russian Orthodox Church and condemned by the Communist Party as a reactionary cult - influenced the emergence of a new movement in modern mathematics.

This movement was the continuation of the work of Georg Cantor on the infinite. The authors argue that "while the French were constrained by their rationalism, the Russians were energized by their mystical faith." The "Russian trio" of **Nikolai Nikolaevich Luzin** (Russian Mathematician; 1883 - 1950), **Dimitri Egorov** (Russian Mathematician; 1869 - 1931), and **Pavel Florensky** (Russian Mathematician; 1882 - 1937) had a deep impact on the development of a powerful Russian mathematical community in the twentieth century. They were clearly on the side of "invention" with Luzin speaking strongly about the importance of naming:

Each definition is a piece of secret ripped from Nature by the human spirit. I insist on this: any complicated thing, being illumined by definitions, being laid out in them, being broken up into pieces, will be separated into pieces completely transparent even to a child,

excluding foggy and dark parts that our intuition whispers to us while acting, separating into logical pieces, then only can we mover further, towards new successes due to definitions.

## 6. Further Investigations

**6.1. Rearranging Paradox.** Another way to see that rearranging infinite series effects the sum is to analyze the alternating harmonic series as we did the the infinitely repeating decimal  $0.999\dots$  previously. Namely, define  $S$  by:

$$S = 1 - \frac{1}{2} + \frac{1}{3} - \frac{1}{4} + \frac{1}{5} - \dots$$

- F1.** Multiply both sides of the equation for  $S$  by 2 to find an infinite series for  $2S$ .
- F2.** Combine terms which share the same denominators and show that the result is  $2S = S$ .
- F3.** We know  $S \neq 0$ , so divide by  $S$  to “show”  $2 = 1$ .
- F4.** Where is it that we have gone astray, or have we really proven that  $2 = 1$ ?

**6.2. Riemann’s Rearrangement Theorem.** Peter Lejeune Dirichlet (; - ) is the earliest person we have on record of being aware that rearranging an infinite series may change its sum. He discovered this in 1827. It was not until 1852 that the question was investigated more fully, this time by Riemann who had sought the advice of his elder Dirichlet. The rearrangement theorem that now bears his name was proven by 1853 but was published posthumously in 1866, and only then because its importance was recognized by **Richard Dedekind** (German mathematician; 1831 - 1916).<sup>4</sup>

Riemann’s Rearrangement Theorem is counterintuitive, showing that infinite series do not satisfy the *commutative law of addition* that we are used to. But in some sense it is maximally counterintuitive, showing that a conditionally convergent series can be rearranged to converge to *any* value one desires! With such surprises, one might expect that proving this result would be very difficult. However, nothing could be further from the case. Rather, the direct and simple proof adds greatly to the beauty of this result.

Here we illustrate intuitively how the proof proceeds. A formal proof relies on little more than rigorous use of the key definitions of the ideas investigated here and below. Our approach follows that of Dunham in The Calculus Gallery who follows Riemann’s original proof.

- F5.** Suppose the infinite series  $\sum_{n=1}^{\infty} a_n$  is convergent. Explain why the individual terms  $a_n$  must *converge* to 0 in the limit as  $n \rightarrow \infty$ .
- F6.** Explain how we can rearrange the infinite series  $\sum_{n=1}^{\infty} a_n$ , which may include both positive and negative terms, into the difference of two infinite series with all positive terms. I.e.  $\sum_{n=1}^{\infty} a_n = (c_1 + c_2 + c_3 + \dots) - (d_1 + d_2 + d_3 + \dots)$  where  $0 \leq c_n, d_n$ . (Note: We chose the labels  $c$  and  $d$  to symbolize the “credits” and “debits” of the original series.)
- F7.** Suppose the infinite series  $\sum_{n=1}^{\infty} a_n$  is conditionally convergent. Explain why the associated infinite series of credits and debits (i.e. the series  $c_1 + c_2 + c_3 + \dots$  and  $d_1 + d_2 + d_3 + \dots$  from Further Investigation **F6**) both must diverge.
- F8.** Pick *any* target value, which we denote by  $T$ , you would like the rearranged series to converge to.
- F9.** Beginning with  $c_1$  begin adding successive credits. Explain why the sum must eventually surpass  $T$ .
- F10.** If you stop adding successive credits as soon as the sum surpasses  $T$ , how far from  $T$  can the sum be?
- F11.** To the credits in Further Investigation **F10** begin subtracting successive debits starting at  $d_1$ . Explain why the sum must eventually fall below  $T$ .
- F12.** If you stop subtracting successive debits as soon as the sum falls below  $T$ , how far from  $T$  can the sum be?
- F13.** Explain how you can continue this process to rearrange the series so it has the form
 
$$(c_1 + c_2 + \dots c_{n_1}) - (d_1 + d_2 + \dots d_{m_1}) + (c_{n_1+1} + c_{n_1+2} + \dots c_{n_2}) - (d_{m_1+1} + d_{m_1+2} + \dots d_{m_2}) + \dots$$
 with partial sums mimicking those in Investigation **10** and Investigation **12**.
- F14.** Explain why the rearrangement just created must have sum  $T$ .

Most infinite series are remarkably hard to analyze, as the quote above from Abel seems to suggest. Whether their sum is finite or not can often be ascertained, but rarely can the exact value of the sum be found. Nonetheless, many important and remarkable infinite series have been discovered, several of them in the search for methods of approximating the ubiquitous constant .

<sup>4</sup>See “Riemann’s Rearrangement Theorem” by Stewart Galanor, *Mathematics Teacher*, vol. 80, no. 8, Nov. 1987, pp. 675-81 and A Radical Approach to Real Analysis by David Bressoud.

The following infinite series is known as the **Gregory series**:

$$1 - \frac{1}{3} + \frac{1}{5} - \frac{1}{7} + \frac{1}{9} - \dots$$

**F15.** Write out the next ten terms in this series.

**F16.** Sum the first five terms in this series.

**F17.** Sum the first ten terms in this series.

**F18.** Show that your answers to the previous problems are close to  $\pi/4$ .

Although it is hard to demonstrate, the Gregory series does have  $\frac{\pi}{4}$  as a sum. That is

$$\frac{\pi}{4} = 1 - \frac{1}{3} + \frac{1}{5} - \frac{1}{7} + \frac{1}{9} - \dots,$$

a fact that was known not only by **Gregory** (; -), but **Leibniz** (; -), **Isaac Newton** (; -), and, almost two centuries earlier than any of these well-known mathematicians, by the Indian mathematician **Nilakantha** (; -).



## Sizes of Infinity

I am so in favor of the actual infinite that instead of admitting that Nature abhors it, as is commonly said, I hold that Nature makes frequent use of it everywhere, in order to show more effectively the perfections of its Author. Thus I believe that there is no part of matter which is not - I do not say divisible - but actually divisible; and consequently the least particle ought to be considered as a world full of an infinity of different creatures.

Georg Cantor (; -)

No one will expel us from the paradise that Cantor has created.

David Hilbert (; -)

### 1. Counting

Our intuition suggests one Infinite; one definitive, universal, unlimited Infinite. As such Galileo's warning that "we cannot speak of infinite quantities as being the one greater or less than another," may seem entirely reasonable - infinity can have only one "size."

Nonetheless, it may have been surprising to see, during your exploration of the Wheel of Aristotle, that the number of points on a large circle is the *same* as the number of points on a small circle. We matched the points - all infinitely many of them - in a *one-to-one* way.

As described in Discovering the Art of Geometry, the discovery of perspective drawing was an important development in the history of art. It was also important mathematically. As **Rudy Rucker** (; -) tells us:

Intellectually, perspective [drawing] is a breakthrough, because here, for the first time, the physical space we live in is being depicted as if it were an abstract, mathematical space. A less obvious innovation due to perspective is that here, for the first time, people are actually drawing pictures of infinities.<sup>1</sup>

Perspective drawing is a valuable tool in our efforts to compare different sizes of infinity. Figure 1 shows a basic *one-point perspective drawing*. Notice that all lines parallel to the line of sight of the viewer converge to the *vanishing point* which represents infinity. The other figure shows how a *point at infinity* allows us to match, i.e. put in a one-to-one correspondence, the points on a line of length one with the points in a line of length two. The number of points on each is the same.

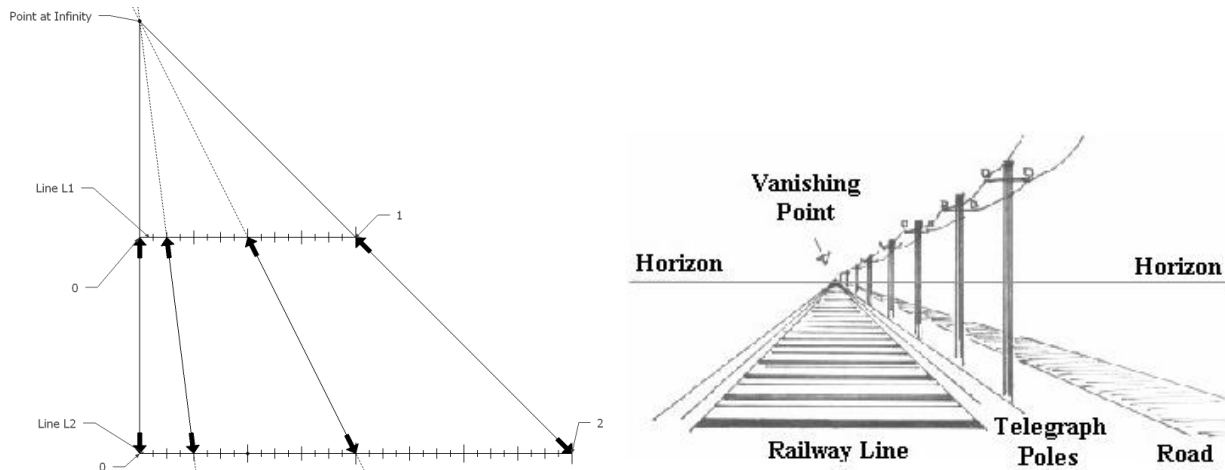

FIGURE 1. Projecting lines.

<sup>1</sup>From Mind Tools: The Five Levels of Mathematical Reality.

## 2. Counting by Matching

Without question, the most important contributions to human understanding of the infinite were made by **Georg Cantor** (German mathematician; - ). As we shall see in the interlude, his work as a champion of the infinite brought him great personal joy coupled with extreme professional hostility and devastating emotional grief.

Cantor's idea, and the profound revelations that follow from it, was simple. If we consider pursuing a quantitative study of the infinite, we need a new way to "count." In the realm of the infinite our standard methods will be of little use. Cantor's idea was to use matching as our way of counting.

It is an obvious choice. Those who cannot count, very small children for example, are certainly aware of such matching. They can tell you whether the number of popsicles in the freezer outnumber the children at the party, or conversely, without counting - they simply try to match popsicles to friends.

Since you already know how to count, let's consider a few examples where matching is important.

1. The NCAA Women's Division 1 Basketball Tournament is a single elimination tournament with 64 teams. Determine how many games are played in this tournament.
2. There are many ways to solve the problem in Investigation 1. A particularly elegant way uses matching. Match losers to games to show how you can immediately determine how many games are played in the tournament.
3. How many games are played in a single elimination tournament with  $2^n$  teams? Explain.
4. Draw several *polygons*.<sup>2</sup> For each count the number of *vertices*, aka corners, and *edges*.
5. How does the number of vertices seem to be related to the number of edges in your polygons.
6. Devise a nice way to match vertices and edges that proves why your relationship in Investigation 5 holds for all polygons.

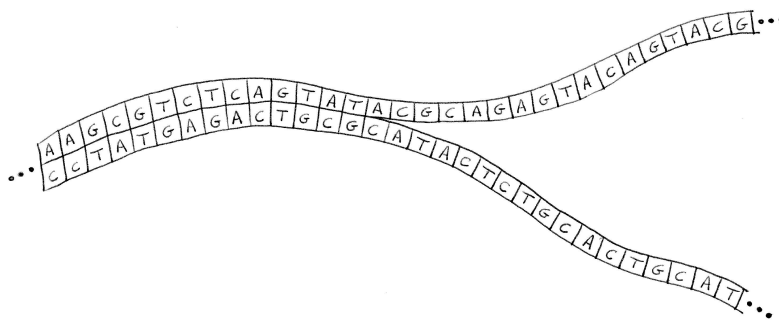

FIGURE 2. Strands of DNA.

Figure 2 is a schematic diagram of *Deoxyribonucleic acid*, also known as DNA. Notice that there are two strands that come together like the two sides of zipper. Each letter represents one of the *bases* adenine(A), cytosine(C), guanine(G), and thymine(T). A base on one strand binds to the base opposite on the other strand. These are called **DNA base pairs**.

7. Look at the base pairs that make up the length of DNA in Figure 2. What do you notice about these pairs?

In fact, the matching that you describe in Investigation 7 is the only kind of matching that is possible, the so-called **complementary base pairing**. When organism grow DNA is replicated. Tremendously long lengths of DNA which are twisted and knotted up somehow knows how to unknot itself<sup>3</sup>, zips into two pieces, and then matches free base pairs to each strand to complete the replication.

In other words, the very basis of life involves matching at the most basic level.

8. Think up your own non-trivial example of matching.

Now that you've thought about matching a bit, let's return to counting. What is it about the number three that gives it its "threeness"? What is common about three kids, three pebbles, three Magi, three daily

<sup>2</sup>It is important to remember that polygons are *simple*, that is, their edges cannot cross and their is only one interior region.

<sup>3</sup>Actually the field of knot theory, which is explored in [Discovering the Art of Knot Theory](#) in this series, is playing a critical role in our efforts to understand the physical chemistry behind DNA replication.

meals, three colors on a stoplight, three races in horseracing's Triple Crown, and all other things we say there are three of? What they share is that we can match the elements that make up each group (set) in a one-to-one way:

Addie ↔ granite ↔ Melchior ↔ breakfast ↔ red ↔ Kentucky derby  
 Jacob ↔ quartz ↔ Caspar ↔ lunch ↔ yellow ↔ Preakness stakes  
 KC ↔ beach glass ↔ Balthasar ↔ dinner ↔ green ↔ Belmont stakes

There are three in each group because each group can be matched with  $\{1, 2, 3\}$  which serves as the defining three element group.

To make this formal in a mathematical way we simply use the language that we have developed before. We notice that the objects of our study will be elements that we have grouped together as sets - just like in Chapter 2. Our way of matching is a **one-to-one correspondence** between two sets  $A$  and  $B$  which we define to be a rule<sup>4</sup> which matches each element from  $A$  with exactly one element of  $B$  and each element of  $B$  with exactly one element of  $A$ .

Previously we used an intuitive notion of the size of sets - we just counted to find the cardinality of a given set. Now we can make a definition - one that we can use for the infinite as well. The set  $\{a, e, i, o, u\}$  has **cardinality** 5, *by definition*, because it can be put in a one-to-one correspondence with the set of the first five natural numbers,  $\{1, 2, 3, 4, 5\}$ . Namely, the matching rule that provides the one-to-one correspondence is

$$a \leftrightarrow 1 \quad e \leftrightarrow 2 \quad i \leftrightarrow 3 \quad o \leftrightarrow 4 \quad u \leftrightarrow 5.$$

9. In Chapter 2 we defined the notion of cardinality informally. Use the formal definition here to check that the cardinality of the sets you investigated in Investigation 18 are the cardinalities you assigned there.

Of course, not all sets have the same cardinality. How does our matching help us count here?

Here's an example. The cardinality of  $\{a, e\}$ , which is 2, is strictly less than the cardinality of  $\{1, 2, 3, 4, 5\}$ , which is 5, simply because

- $a$  and  $e$  can be put in a one-to-one correspondence with any pair of elements from  $\{1, 2, 3, 4, 5\}$
- $a$  and  $e$  can never be put in one-to-one correspondence with all of  $\{1, 2, 3, 4, 5\}$ .

So we say the cardinality of  $\{a, e\}$  is strictly less than the cardinality of  $\{1, 2, 3, 4, 5\}$  and we write  $2 < 5$ .

This is obvious, there's nothing surprising here. Yet...

Let us see what happens when we compare infinite sets in this way.

### 3. Comparing Infinite Sets

10. Let  $S = \{1, 4, 9, 16, \dots\}$  be the set of squares. Name seven other elements of this set.
11. Intuitively, which is larger, the set  $S$  of squares or the set  $N = \{1, 2, 3, \dots\}$  of natural numbers?
12. Express the set  $S$  by writing each element as a square.
13. Use Investigation 12 to find a one-to-one correspondence between the set  $S$  of squares and the set  $N$  of natural numbers.
14. What does Investigation 13 tell you about the relative sizes of the set  $S$  of squares and the set  $N$  of natural numbers?
15. How does your answer to Investigation 14 compare with your answer to Investigation 11?

The apparent paradox indicated in Investigation 15 is known as **Galileo's paradox**. This paradox prompted Galileo to conclude:

We can only infer that the totality of all numbers is infinite, and that the number of squares is infinite...; neither is the number of squares less than the totality of all numbers, nor the latter greater than the former; and finally, the attributes "equal," "greater," and "less," are not applicable to infinite, but only to finite quantities.

As we have noted, Galileo's conclusion is intuitively compelling and was generally accepted by mathematicians and philosophers for millennia. What we will discover is that if we open our minds as Cantor did, the infinite is a much richer, varied landscape.

Figure 1 shows a perspective-like drawing. The point 0 on  $L_1$  is matched with the point 0 on  $L_2$  and the point 1 on  $L_1$  is matched with the point 2 on  $L_2$ .

16. Using the matching illustrated in Figure 1, what point on  $L_2$  does the point  $\frac{1}{2}$  on  $L_1$  correspond to?
17. Similarly, what point on  $L_1$  would the point  $\frac{1}{4}$  on  $L_2$  correspond to?

There is an enlarged version of Figure 1 in the appendix. Use it to help with the following investigations.

<sup>4</sup>More formally, the "rule" is a *function* that is both *one-to-one* and *onto*.

18. What point on  $L_2$  does the point  $\frac{7}{8}$  on  $L_1$  correspond to?
19. What point on  $L_1$  does the point  $\frac{11}{16}$  on  $L_2$  correspond to?
20. Explicitly find the correspondence between several points on  $L_1$  and  $L_2$ .
21. Can you find a general rule or description to describe the one-to-one correspondence between the points on  $L_1$  and  $L_2$  precisely?
22. Adapt Figure 1 to find a one-to-one correspondence between lines  $L_1$  of length one and  $L_3$  of length 3.
23. Can you describe this one-to-one correspondence precisely as you did the other in Investigation 21?
24. Adapt Figure 1 to find a one-to-one correspondence between lines  $L_1$  of length one and  $L_{10}$  of length 10.
25. Can you describe this one-to-one correspondence precisely as you did the other in Investigation 23?
26. Will the method you have been using provide a one-to-one correspondence between any two lines with finite lengths? Explain.
27. Can you use this method to find a one-to-one correspondence between a line  $L_1$  of length one and a line  $L_\infty$  which extends indefinitely in both directions? Explain.

Consider Figure 3 below, where points on the semicircle  $L_{\text{Circle}}$  are projected onto the line  $L_\infty$  extending indefinitely in both directions. In three dimensions projections of this sort are the fundamental tool used to map our spherical earth onto flat maps. All projections introduce distortions, the type (e.g. distorted areas, distorted distances, or distorted angles) of which depends on the mathematical nature of the projection chosen. Which map is “best” is a continuing source of significant controversy.<sup>5</sup>

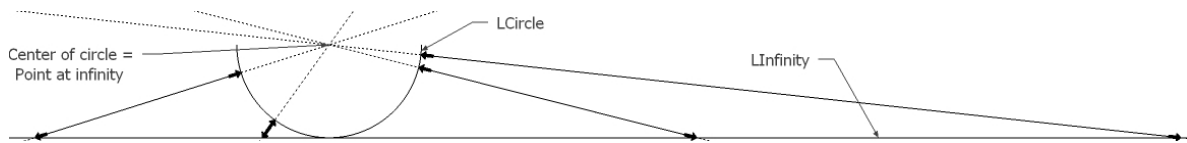

FIGURE 3. Stereographic projection.

28. Does Figure 3 help provide a one-to-one correspondence between  $L_C$  and  $L_\infty$ ? Explain.
29. What do all the results in Investigations 21-28 tell you about the cardinalities of line segments?

#### 4. Sets of Sets

The notion of a set is fundamental to all of mathematics. Cantor was lead to a study of the foundations of *set theory* by uncovering surprising examples in trying to solve practical mathematical problems. One of his most fundamental contributions, known as *Cantor's theorem*, requires a fundamental observation that we can create sets of sets.

Whenever all of the elements of a set  $B$  also belong to a set  $A$  we say  $B$  is a **subset** of  $A$  and we write  $B \subset A$ . For example,  $\{a, e, i, o, u\} \subset \{a, b, c, \dots, x, y, z\}$  and  $\{1, 3, 5, \dots\} \subset \{1, 2, 3, \dots\}$ .

30. Find all subsets of the set  $\{1, 2, 3, 4\}$  which have cardinality three. (Note: Don't forget, a subset is a set itself and so its elements should be contained by braces.)
31. Find all subsets of the set  $\{1, 2, 3, 4\}$  which have cardinality two.
32. Find all subsets of the set  $\{1, 2, 3, 4\}$  which have cardinality one.

Cantor said a “set is a many that is thought of as a one.” Let's see how we can apply that to make sets of sets.

33. The New England Patriots are a professional football team in the National Football League (NFL). Explain how we can think of the Patriots as a set. What are the elements of this set?

There are 32 teams in the NFL. We can make this many into a one - a set - easily:  
 $\text{NFLTeams} = \{\text{Bills, Steelers, Browns, Raiders, Chiefs, } \dots, \text{Saints, Patriots}\}$  .

34. Tom Brady is the quarterback of the Patriots, so he is a member of that team/set. Explain why Tom Brady is not a member of the set NFLTeams.
35. If we wanted to create the set NFLPlayers which consisted of all current NFL players, how would it differ from NFLTeams? How would the cardinlities of these two sets differ?

<sup>5</sup>See, for example, the discussion in [Discovering the Art of Geometry](#) in this series.



An important way to make sets of sets is to form the **power set** of a given set  $S$ . This set is written  $P(S)$ , and is, by definition, the set of all subsets of  $S$ .

It is typical to say that a set is a subset of itself, after all, each element in the (sub)set is also an element of the set. It is also typical to say that the set which contains no elements is a subset of each set. This trivial set is called the **empty set** and is denoted by  $\emptyset$ .

- 36.** Let  $S = \{1, 2, 3, 4\}$ , as above. Use your results above to write out the power set  $P(S)$  in its entirety. (Hint: There should be 16 elements, each of them a set in its own right.)
- 37.** Suppose now we removed the element 4 from the set  $S$ . I.e., suppose  $S = \{1, 2, 3\}$ . Write out the new power set  $P(S)$ .
- 38.** What is the cardinality of the power set  $P(S)$  in Investigation **37**?
- 39.** Now suppose we have also removed the element 3 so  $S = \{1, 2\}$ . Write out the power set  $P(S)$ .
- 40.** What is the cardinality of the power set  $P(S)$  in Investigation **39**?
- 41.** Suppose finally that we removed the element 2 as well so  $S = \{1\}$ . Write out the power set  $P(S)$ .
- 42.** What is the cardinality of the power set  $P(S)$  in Investigation **41**?
- 43.** Using the results of these investigations, how does the cardinality of a finite set  $S$  appear to be related to the cardinality of its power set  $P(S)$ ?
- 44.** The pattern you described in Investigation **43** continues indefinitely. Explain why it is appropriate to write

$$\text{Card}(P(S)) = 2^{\text{Card}(S)}.$$

## 5. Cantor's Theorem and Transfinite Cardinal Numbers

Numbers denoting the cardinality of sets are called **cardinal numbers**. We know there are sets of cardinality  $1, 2, 3, \dots$ . Cantor's theorem shows us that there is an entire hierarchy of cardinal infinities beyond the finite cardinal numbers. His theorem is as follows:

**THEOREM 5.** (Cantor) *Given any sets  $S$ , the power set  $P(S)$  has a strictly larger cardinality.*

In light of what you saw in Investigation **44**, Cantor's theorem does not seem surprising. However, Cantor's theorem applies to infinite sets as well and thus guarantees that there are *strictly* larger sizes of each infinity!

To give it a symbolic name, we denote the cardinality of the natural numbers by  $\aleph_0 = \text{Card}(N)$ . Here  $\aleph$  is **aleph**, the first letter in the Hebrew alphabet. The subscript 0 is because this is the first, or smallest, infinite cardinal number.

- 45.** Explain why the cardinality of the set of squares  $\{1, 4, 9, 16, \dots\}$  is  $\aleph_0$ .
- 46.** Explain, directly without the use of Cantor's theorem, why the power set of the natural numbers,  $P(N)$ , must be an infinite set.
- 47.** Mathematicians generally refer to the cardinality of  $P(N)$  by  $2^{\aleph_0}$ . Explain why.
- 48.** What does Cantor's theorem tell you about the relative sizes of the two infinite cardinal numbers  $\aleph_0$  and  $2^{\aleph_0}$ ?
- 49.** Because  $P(N)$  is itself a set, we can form its power set -  $P(P(N))$ . Why is  $2^{2^{\aleph_0}}$  a good name for the cardinality of this set of sets?
- 50.** What does Cantor's theorem tell you about the relative sizes of the cardinal numbers  $\aleph_0$ ,  $2^{\aleph_0}$ , and  $2^{2^{\aleph_0}}$ ?
- 51.** Explain how this process can be extended indefinitely to find an infinite number of different sizes of infinite cardinals.

As we describe in the Interlude, Cantor was a deeply religious man who was attacked by many for his exploration of the infinite. Throughout his groundbreaking work Cantor clearly distinguished between what he referred to as *transfinites* and what others thought of as *completed infinities*. Cantor's defense, in his own words, is:

I have never proceeded from any "Genus supremum" of the actual infinite. Quite the contrary, I have rigorously proven that there is absolutely no "Genus supremum" of the actual infinite. What surpasses all that is finite and transfinite is no "Genus"; it is the single, completely individual unity in which everything is included ... which by many is called "God."<sup>6</sup>

- 52.** Explain how your result in Investigation **51** is related to Cantor's quote about God.
- 53.** Find and then briefly describe several other important mathematical and/or scientific developments whose proponents were attacked because their views did not conform to prevailing religious views.

<sup>6</sup>Quoted in Georg Cantor: His Mathematics and Philosophy of the Infinite by Joseph Warren Dauben, p. 290.

54. How might we judge these controversies in hindsight given the benefits of a great many years experience?

## 6. Hilbert's Hotel

The development in the previous section of an infinite hierarchy of infinities of increasing size relied on Cantor's theorem and building sets of sets. How, you may ask, do we know that Cantor's theorem is true? At a major conference in 1999, the author gave a talk entitled "Cantor's Theorem: Mathematics' Most Accessible Masterwork." The proof of Cantor's theorem, which included clarifying examples, fit on less than one-half of a single overhead slide which used 36 point font!<sup>7</sup> Alas, if you find sets of sets a bit abstract, this proof is not entirely enlightening. If you feel this way a natural question to ask is:

If there are infinitely many different sizes of infinity, can't you just show us an example of two different sizes?

Good question. This is where we now turn.

One way of describing one-to-one correspondences between certain infinite sets has become known as Hilbert's Hotel after **David Hilbert** (; - ).<sup>8</sup>

You really need to use your imagination to conceptualize Hilbert's hotel. Several people have written science fiction about this hotel. Here's our version:

You awake, groggy and a bit disoriented. You walk around but do not recognize much. Up the street you see a strange but otherwise unimposing building which appears to be called Hilbert's hotel. Your view of it looks like the image in Figure 4.



FIGURE 4. A view of Hilbert's hotel.

At first the building seems very tall, like you are viewing it from its base in an exaggerated perspective. But you realize that the floors are actually getting smaller very quickly.

Nonetheless, it looks harmless enough, so you go in.

It seems nice. You notice a very big group of alien looking creatures. Each wears a number on its chest, almost like a nametag, and holds in their hand a small card which is similarly numbered. They look at like Figure 5.

You approach the desk, hoping there is an available room where you can regroup and try to figure out what's going on.

<sup>7</sup>For a similar example in print, see p. 50 of *Mathematics: A New Golden Age* by Keith Devlin.

<sup>8</sup>In *One, Two, Three ... Infinity* **George Gamow** (; - ) attributes this description to "the unpublished, and even never written, but widely circulating volumes: "The Complete Collection of Hilbert Stories" by **Richard Courant** (; - )."

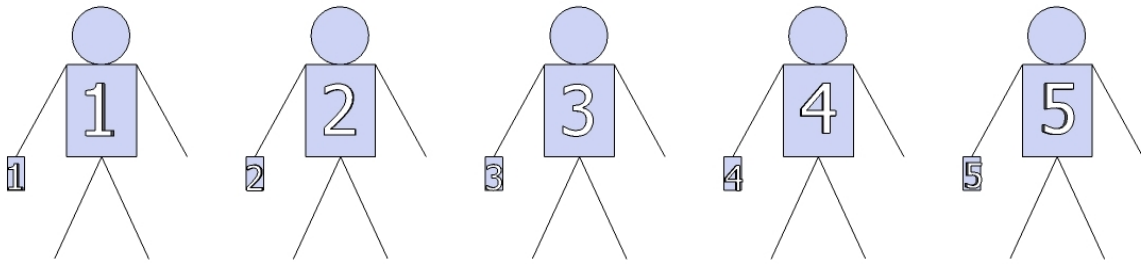

FIGURE 5. Some of the natural number guests at Hilbert’s hotel.

“Do you have any available rooms,” you ask.

The clerk responds, “No, we are completely full. The natural numbers have the entire hotel booked.” You pause, trying to figure out your next move. “Would you like to stay?” “I thought you said you were completely full.” “We are, but this is Hilbert’s hotel, we have infinitely many rooms.”

You should have just accepted the offer, but you can’t help asking, “How can you have infinitely many rooms?” “We have 20 rooms on each layer and infinitely many layers” the clerk says nonchalantly. You think back to your strange view of the hotel’s facade. “Do you want a room or not?” the clerk asks. “Yes, please.” “Do you mind being scaled?” “Yes, scaled. Compressed. Reduced. Shrunk. Even though it is perfect harmless, some people object to this. So we put them in the lower layers. If you’re on the second layer the elevator only scales you to have your size. On the third layer you’re scaled to one-quarter of your size.” The clerk senses your confusion. “I’ll just put you in Room 1 right here in the first layer so you are comfortable.”

“Hey 1,” the clerk yells. “We need to accomodate this newbie. Can you please get your group to all move down a room?” “Certainly,” 1 responds. S/he hands you the card imprinted with a 1. You realize that it is a key card for your room, Room 1. You see 1 return to the group. 2 hands 1 the keycard for Room 1, 3 hands 2 the keycard for Room 2, and so on. 20 gives up the keycard for Room 20 and heads off to the elevator. “Where’s 20 going?” you wonder, feeling badly that you’ve kicked somebody out of their room. “Up to level 2. Room 21 will now be 20’s room and the other guests will also move down. 999,999,999 will be really happy to have the Million Room.”

- 55.** Describe all guests that have to move to another layer due to your arrival.  
**56.** Suppose another guest arrived looking for a room. Could they be accomodated? How?

You sleep soundly and as you awake you hope that you are back in your own world. As you adjust to the rooms low light you realize you are still at Hilbert’s hotel. After a shower you get dressed and head to the lobby to find some food.

As you approach the desk a different clerk yells at you, “You’re late. Where have you been, we’re swamped? Here’s your jacket.” You take the jacket which you see has your name on the left and “maître d’” on the left.

People - of the alien number sort that you saw yesterday - are clamoring for rooms. You see 0, -1, -2, -3, -4 and -5 and a long line leading out the door. “Are all of the negative integers here?” you wonder.

Quickly you look at the registry from two nights before. It looks as follows:

Room Number	Guest Name
1	1
2	4
3	9
4	16
5	25
⋮	⋮

- 57.** With the registry above, did the “squares” fill every room of Hilbert’s hotel? Explain.  
**58.** The positive integers  $\{1, 2, 3, \dots\}$  are staying another night. How can you accomodate 0 and the negative integers  $\{\dots, -3, -2, -1\}$ . (Note: And there is no room-sharing allowed! Hint: What happens if you move 1 to Room 4 and 2 to Room 6?)

**59.** Later in your shift the phone rings. The caller asks if there is a vacancy for Sunday night. You look in the registry and see that no rooms are booked. “How many in your party?” you ask. The caller responds “ $\aleph_0$ .” Can the group be accomodated? If so, explain precisely how you can assign rooms.

There are many other important sets that can be accomodated by Hilbert’s Hotel - including those we might think would be too big. For example, the set of all fractions (a.k.a., the *rational numbers*) can be accomodated; they have cardinality  $\aleph_0$ . Even the set of solutions of *every* algebraic equation (which are called the *algebraic numbers*) can be accomodated. They too have cardinality  $\aleph_0$ .

**7. Nondenumerability of the Continuum**

What Cantor showed in his groundbreaking 1873<sup>9</sup> discovery, was that the set of all points that make up the **unit interval** of the real number line,  $[0, 1]$ , *cannot* be accomodated by Hilbert’s Hotel. This set of points is too big. In other words, the cardinality of the unit interval  $[0, 1]$ , which is usually denoted by  $Card([0, 1]) = c$  for *continuum*, is strictly greater than  $\aleph_0$ ! In other words, a set that we know intimately has a higher cardinality than  $\aleph_0$ .

To show that the points in the unit interval cannot be accomodated by Hilbert’s Hotel we need to show that *every* possible Hilbert’s Hotel registry will leave out at least one point in the unit interval. To get a sense of what this entails, we are returning you to your role of maître d of Hilbert’s Hotel.

Room Assignment	Guest
1	0. _ _ _ _ _ _ _ _ _ _ ...
2	0. _ _ _ _ _ _ _ _ _ _ ...
3	0. _ _ _ _ _ _ _ _ _ _ ...
4	0. _ _ _ _ _ _ _ _ _ _ ...
5	0. _ _ _ _ _ _ _ _ _ _ ...
6	0. _ _ _ _ _ _ _ _ _ _ ...
7	0. _ _ _ _ _ _ _ _ _ _ ...
8	0. _ _ _ _ _ _ _ _ _ _ ...
⋮	⋮

FIGURE 6. Guest Registry for  $[0, 1]$  - first attempt.

- 60.** Write down 20 different points that belong to the unit interval  $[0, 1]$ .
- 61.** Describe the points in  $[0, 1]$ . What can you say about them as decimals?
- 62.** Assign some point in  $[0, 1]$  to Room 1 in the registry above by writing its decimal digits in the appropriate places. If the decimal is finite, after it terminates write zeroes to the right of the final decimal digit as in  $0.7168366610 = 0.716836661000\dots$  If the decimal is infinite, give at least the first ten digits.
- 63.** Assign some other point in  $[0, 1]$  to Room 2 in the registry above, as you did in Investigation **62**.
- 64.** Assign some remaining point from  $[0, 1]$  to Room 3 in the registry above, as you did in Investigation **62**.
- 65.** Assign some remaining point from  $[0, 1]$  to Room 4 in the registry above, as you did in Investigation **62**.
- 66.** Repeat Investigation **65** four more times.
- 67.** If you continued to assign rooms like this, would there ever be a point at which every point in  $[0, 1]$  had been assigned a room? Explain.
- 68.** Suppose you were able to assign rooms faster and faster so that in a finite amount of time all infinitely many rooms in Hilbert’s Hotel had been assigned - almost in reverse of how we can add up infinitely many terms of a series and get a finite sum. Do you think that then all of the points in  $[0, 1]$  will have been accomodated? Explain.

It is my sad duty to inform you that you that even if you have completed your entire registry, you have not assigned rooms for all members of  $[0, 1]$ . I know this because you are going to help me find a number of  $[0, 1]$  that you have not assigned a room to.

We’re going to find this number one decimal at a time. We will represent this number by the decimal  $0.d_1d_2d_3d_4\dots$

<sup>9</sup>See, e.g., p. 50 of Georg Cantor: His Mathematics and Philosophy of the Infinite by Joseph Warren Dauben.

69. Circle the first decimal digit of the guest you have assigned to Room 1. If this digit is a 1, then define  $d_1 = 3$ . If it isn't a 1, then define  $d_1 = 1$ .
70. Circle the second decimal digit of the guest you have assigned to Room 2. If this digit is a 1, then define  $d_2 = 3$ . If it isn't a 1, then define  $d_2 = 1$ .
71. Circle the third decimal digit of the guest you have assigned to Room 2. If this digit is a 1, then define  $d_3 = 3$ . If it isn't a 1, then define  $d_3 = 1$ .
72. Continue this process to define the digits  $d_4, d_5, d_6, d_7$  and  $d_8$ .
73. If you had assigned rooms for more points in  $[0, 1]$  could you continue to assign decimal digits  $d_n$  in this same way? For how long?
74. Now write down the number  $0.d_1d_2d_3d_4\dots$ . Does this decimal represent a unique, well-defined real number in the unit interval  $[0, 1]$ ? Explain.
75. Explain why  $0.d_1d_2d_3d_4\dots$  is not the guest in Room 1.
76. Explain why  $0.d_1d_2d_3d_4\dots$  is not the guest in Room 2.
77. Explain why  $0.d_1d_2d_3d_4\dots$  is not the guest in any of the Rooms 3 - 8.
78. Explain how I know that  $0.d_1d_2d_3d_4\dots$  will not be in Room 37.
79. Explain how I know that  $0.d_1d_2d_3d_4\dots$  has not been assigned to any of the rooms that you assigned - even if you have assigned *every* room in Hilbert's hotel.

You have failed in your task of assigning all points in  $[0, 1]$  a room. But so did your peers. This same rule that I used to find a point that you did not assign a room to can be used to show that your peers have missed points as well. Their roomless guest points will likely be different, but they will be found in the same way. In other words, this rule will find a point that is missing from *any* possible guest registry for Hilbert's Hotel.

From this failure we can only conclude that no such guest registry is possible; i.e. that the points in  $[0, 1]$  are too numerous to fit in Hilbert's Hotel. This means that the cardinality  $c$  is a different cardinality than  $\aleph_0$ . We now have two different sizes of infinity.

## 8. The Continuum Hypothesis

Cantor rapidly developed the hierarchy of infinite cardinals that begins as we have described above as a result of Cantor's theorem. As we shall discover in the next chapter he also developed an infinite hierarchy of *infinite ordinals*. And he developed a beautiful relationships between these two different conceptions of quantifiable infinite.

Yet he spent much of the latter part of his life vexed by a single question: are there sets whose cardinality is between  $\aleph_0$  and  $c$ ? Cantor believed that there was no such set - that the infinite cardinal  $c$  followed the first infinite cardinal  $\aleph_0$  immediately. This result became known as the **continuum hypothesis**. It is likely that his inability to solve this problem, coupled with his contentious relationships with other prominent mathematicians of the day about matters involving the infinite, contributed to his declining mental status. So important is this problem that it was the first of *Hilbert's problems*, a list of 23 problems posed in 1900 that were to focus mathematical research through the twentieth century.

Cantor died before this problem was resolved.

But Cantor had the last laugh. Beginning with the most widely used basis for set theory<sup>10</sup> **Kurt Godel** (; -) *proved* in 1938 that the continuum hypothesis is *consistent* with the axioms; i.e. it cannot be disproved. But, decade after decade, no proof was forthcoming. In 1963, **Paul Cohen** (; -) *proved* that the continuum hypothesis cannot be disproved with these same axioms. In other words, these two mathematicians *proved* that Cantor's continuum hypothesis was *undecidable*.<sup>11</sup>

Cantor did not know the answer; nobody else will either.

- 80. Classroom Discussion:** In writing about Cantor's proof of the *uncountability* of the continuum, **William Dunham** (American mathematician and author; -) wrote:

Any layman who, in 1874, had visited Paris to see the paintings of Claude Monet would have been struck by the "impressionist" techniques the artist had introduced. Even the casual observer would have seen in Monet's brushwork, in his rendering of light, a significant departure from the canvases of such predecessors as Delacroix or Ingres. Clearly something radical was going on. Yet in this mathematical landmark of the same year, Georg Cantor had set our upon a course every bit as revolutionary. It is just that mathematics on the printed page often lacks the *immediate* impact of a radical piece of art.

<sup>10</sup>*Zermelo-Fraenkel set theory* with the inclusion of the *axiom of choice*.

<sup>11</sup>For more on issues related to proof, undecidability, and incompleteness, see see [Discovering the Art of Logic, Proof, Truth, and Certainty](#) in this series.

You have now had the opportunity to work with this radical idea that there are different sizes of infinity. You have “seen” it with your own intellect. What do you think? Is this piece of work worthy of the title “revolutionary”? Is this work beautiful? Do you see how it may have a lasting impact on all future considerations of the infinite?

## 9. Further Investigations

**9.1. Comparability of Transfinite Cardinals.** We showed above that the points in the unit interval  $[0, 1]$  cannot be accommodated by Hilbert's Hotel. This suggests that  $\aleph_0 \leq c$ . But how do we know these numbers are even comparable?

**F1.** Match each natural number  $n$  with the real number  $\frac{1}{n}$ . Show that this matches the natural numbers with a *subset* of  $[0, 1]$ .

**F2.** Explain how this shows that  $\aleph_0 \leq c$ .

In standard arithmetic knowing that  $a \leq b$  and  $b \leq a$  guarantees that  $a = b$ . A similar result holds in cardinal arithmetic. But here it is not a triviality, because the equality means that we can find a one-to-one correspondence between two sets from knowledge of one-to-one correspondences with proper subsets. This critical result is known as the ***Cantor-Schroder-Bernstein theorem***.

**9.2. Foreshadowing Russell's Paradox.** Cantor noted that his theorem illustrates a deep paradox of set theory. Having talked about many different sizes of infinity we might want to think about the set of all sets. Name this set  $U$ . In some sense,  $U$  is the largest possible set - the *universe of all sets*.

**F3.** Apply Cantor's theorem to the set  $U$ . What conclusion does it allow you to make about the relative sizes of  $U$  and  $P(U)$ ?

**F4.** Explain how the conclusion of the previous problem contradicts the very definition of the set  $U$ .

In contrast with our earlier paradoxes, this paradox is neither caused by limitations of Cantor's theorem nor our conceptions of the infinite. It is a logical paradox based on our intuitive ideas of the notion of a set, one that can be formulated in settings where the infinite is not involved. The most basic version of this paradox is called *Russell's paradox* which is considered in detail in the volume Discovery the Art of Reasoning, Proof, Logic and Truth in this series.

While troubling, these paradoxes are something mathematicians have come to live with:

The set-theoretical paradoxes are hardly any more troublesome for mathematics than deceptions of the senses are for physics.

**Kurt Gödel** (; -)

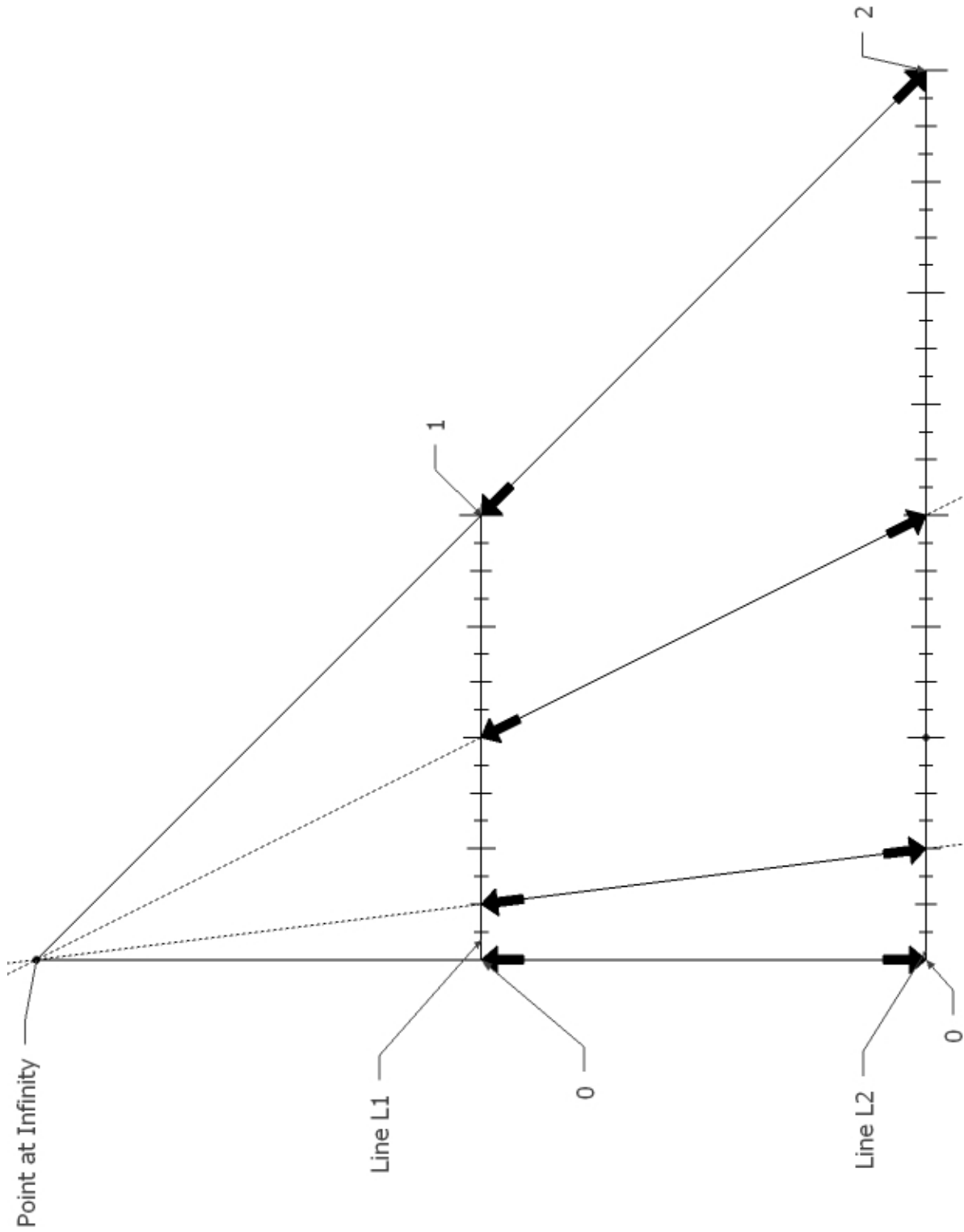

FIGURE 7. Larger version of Figure 1.



## Georg Cantor: Chamption of the Infinite

This view [of the infinite], which I consider to be the sole correct one, is held by only a few. While possibly I am the very first in history to take this position so explicitly, with all of its logical consequences, I know for sure that I shall not be the last!

**Georg Cantor** (German mathematician; 1845 - 1918)

My theory stands as firm as a rock; every arrow directed against it will return quickly to its archer. How do I know this? Because I have studied it from all sides for many years; because I have examined all objections which have ever been made against the infinite numbers; and above all because I have followed it roots, so to speak, to the first infallible cause of all created things.

**Georg Cantor** (; - )

Georg Cantor was the eldest of six children born to Georg Woldemar Cantor and Maria Anna Bohm. He was raised as a strict Lutheran in St. Petersburg, Russia, then Weisbaden and Frankfurt, Germany. His father was a successful businessman despite several difficult failures. In addition to instilling strong religious faith and diligent work ethic in his children, the elder Georg Cantor also expected his children to be active students of the liberal arts and sciences. This included the study of music, an area where many relatives were well known, literature, art, mathematics, the physical sciences and the natural sciences. In the elder Cantor's own words:

To the procurement of diverse, thorough, scientific and practical knowledge; to the perfect acquisition of foreign languages and literatures; to the many-sided development of the mind in many humanistic disciplines – and of this you must always be thoroughly conscious! – to all this the second period of your life, your youth, now just beginning, is destined, in order first to equip yourself with dignity by means of all this for those struggles yet to come.

While a strong supporter of his children, he had unusually high expectations for his first born son and namesake Georg. In a letter to the then fifteen year old Georg on the occasion of his confirmation (the same letter quoted above) the elder Cantor seemed to predict the course of his son's future:

How often the most promising individuals are defeated after a tenuous, weak resistance in their first serious struggle following their entry into practical affairs. Their courage broken, they atrophy completely thereafter, and even in the best case they will still be nothing more than a so-called ruined genius! . . . But they lacked that steady heart, upon which everything depends!... This sure heart, which must live in us, is: a truly religious spirit!

. . . I close with these words: Your father, or rather your parents and all other members of the family both in Germany and in Russia and in Denmark have their eyes on you as the eldest, and expect you to be nothing less than a Theodor Schaeffer [young Cantor's teacher] and, God willing, later perhaps a shining star on the horizon of science.

By 1862 Cantor's studies had come to a crossroads. He was drawn to mathematics, but was worried that this calling was not among his father's expectations. His father, who would die a short time later in his mid-fifties, was in fact supportive of Cantor's desire to pursue mathematics. Georg's glowing reaction to this support, a state that would later become part of a cycle of manic highs and lows, is evident in a letter to his father:

My Dear Papa! You cannot imagine how very happy your letter made me; it determines my future. The last few days have left me in doubt and uncertainty. I could reach no decision. My sense of duty and my own wishes fought continuously one against the other. Now I am happy when I see that it will not longer distress you if I follow my own feelings in this decision. I hope that you will still be proud of me one day, dear Father, for my soul, my entire being lives in my calling; whatever one wants and is able to do, whatever it is toward which an unknown, secret voice calls him, that he will carry through to success

For the next several years Cantor studied at the University of Berlin under some of the greatest living mathematicians, including: Kummer, Kronecker, and Weierstrass. After passing the required exams he

became a Privatdozent at the university in Halle, near Leipzig. Originally interested in number theory, Cantor soon turned toward analysis where critical progress was being made in understanding the foundations of calculus after a 200 year struggle that had seen little or no previous progress.

In Cantor's work the nature and structure of the real number system and its subsets proved to be a critical and insufficiently understood landscape. By 1872 he had essentially solved one of the main open problems in the area of trigonometric series. In solving this problem Cantor realized that "the number concept... carries within it the germ of a necessary and absolutely infinite extension." His investigation of the infinite, or the transfinite as Cantor called it, that this solution necessitated would occupy the majority of Cantor's subsequent mathematical life.

Cantor's work on the infinite was as revolutionary as it was unexpected and controversial. Cantor was almost single-handedly responsible not only for the germination of the critical ideas that brought rigor and certainty to the study of the infinite, but also for unceasing devotion to nurturing this theory so that "once mathematicians were ready to consider the significance of the transfinite numbers, the entire theory would be ready to stand on the foundations he had given it." So complete and revolutionary was this development that it is unparalleled in scope and significance by any event in the history of mathematics short of Newton's invention of calculus.

Yet this revolution was not completed without considerable hardship on Cantor. The infinite and the infinitesimal had been banished by many mathematicians as the root cause of the unstable foundation for calculus. Cantor's work met vigilant resistance at every stage. The strongest resistance came from the German mathematical community lead by **Leopold Kronecker** (German mathematician; - ). Cantor was unable to lure prominent mathematicians to collaborate with him at the Halle and was unable to secure a prominent position at a more prestigious German university even as his monumental efforts were being recognized by mathematicians and many learned societies outside of Germany.

In addition Cantor's strong philosophical and theological beliefs made his ongoing defense of transfinities that much more difficult. His transfinities were broadly regarded as heretical – contrary to the existence of the Almighty. For such a deeply faithful man raised in the strict Lutheran tradition this was unacceptable. Hence, his efforts to secure the proper place of the transfinities took on a critical theological perspectives as well, and he addressed this issue in detail in many publications. Cantor's theory met with philosophical objections which he felt compelled to address. Finally, perhaps due in part to his fathers hope that Cantor would devote himself to a more applicable calling than pure mathematics, Cantor attempted to use his transfinities to develop an "organic explanation of nature." Cantor was compelled to defend his transfinities against the attacks of mathematicians, theologians, philosophers, and scientists simultaneously.

Cantor's great strength and determination, religious faith, and profound intellectual calling – instilled in him since childhood – allowed him to make remarkable progress in uncovering the mystery of the infinite and defending it against myriad attacks from many fronts for some thirty years. Unfortunately, a fragile mental state did not allow Cantor to continue to champion his theory of transfinities effectively past the age of sixty. Recent evidence suggests Cantor's mental difficulties can be attributed to manic depression. His first serious mental breakdown was in 1884. While he did not suffer another serious breakdown until 1899, the same year his son died four days before his fourteenth birthday, his anxiety about opposition to his theory and perceived persecution increased dramatically. By the time of the Third International Congress for Mathematicians in 1904 he had been in the sanitarium twice more for extended periods. At this Congress Jules Konig presented a paper that appeared to destroy the heart of Cantor's theory. Cantor fumed, hounding notable mathematicians to regale them with possible stumbling blocks in Konig's theory. While Konig's argument eventually was shown to be poorly grounded, this episode marked a final turning point in Cantor's defense of the transfinities. After this he spent more and more time in sanitariums, often for periods close to a year. Shortly before his death on 6 January, 1918, at the age of 73, Cantor wrote a poem to his wife which ends as follows:

To suffer gladly, pen a poem,  
To escape the world I'm in.

Perhaps the most sticking irony in the celebrated yet troubled life of Georg Cantor is the nature of two mathematical difficulties that plagued his theory so strongly but resisted his greatest efforts. Cantor's theory of transfinities relied heavily on the extant theory of sets. By the turn of the century there were many paradoxes that Cantor's theory seemed to give rise to. It is now quite clear that it was not Cantor's theories of the infinite that gave rise to these paradoxes, rather it is our naive notions of set theory. These notions and the extant theory contain in their most basic elements a host of damaging paradoxes that arise even in finite situations. Second, the key missing result in Cantor's entire theory was what we referred to as the Continuum Hypothesis at the end of the previous chapter. His inability to obtain closure on this key result

was certainly a devastating failure to him. But, as we have said, herein lies the ultimate irony - within the confines of typical set theory, the Continuum Hypothesis is undecidable!



## The Ordered and Surreal Landscapes of Infinity

The transfinite numbers are in a certain sense themselves new irrationalities and in fact in my opinion the best method of defining the finite irrational numbers is wholly similar to, and I might even say in principle the same as, my method described above of introducing transfinite numbers. One can say unconditionally: the transfinite numbers stand or fall with the finite irrational numbers; they are like each other in their innermost being; for the former like the latter are definite delimited forms or modifications of the actual infinite.

**Georg Cantor** (; -)

Instead of worrying if we really can squeeze a number like  $\frac{1}{\omega}$  in above zero but below  $\frac{1}{2}, \frac{1}{3}, \frac{1}{4}, \frac{1}{5}$ , etc., Conway suggests that we relax and just define  $\frac{1}{\omega}$  in terms of the gap between zero and all the  $\frac{1}{n}$ .

**Rudolf von Bitter Rucker** (American Mathematician and Author; 1946 -)

### 1. What's Next?

As we've seen, Cantor's theory of cardinal numbers is based in large part on a playful, almost childlike use of matching to determine "how big?" It is a basic idea which Cantor followed logically to its extreme, into the realm of the transfinities.

In considering the same natural numbers  $1, 2, 3, \dots$  the notion of "what's next?" is an equally basic idea. This insight was clear to Cantor who extended this idea to its logical extreme much as he had the notion of "how big" to create the cardinal numbers. The result was the birth of another system of numbers, the *ordinal numbers*, which we will consider now.

### 2. The Ordinal Numbers

The natural numbers  $1, 2, 3, \dots$  are endowed with a natural order. Each number is the immediate predecessor of the number which follows it. We have written them in this natural order from left to right. Of course, this is an order that continues indefinitely. At any point in the order the child's injunction "plus one" takes us to the next natural number in the order. From 9 we move to  $9 + 1$ , a.k.a. 10.

But we need not think of 10 only as the number immediately following 9; its *immediate successor*. We can also think of 10 as the immediate successor of the whole collection  $\{1, 2, 3, 4, 5, 6, 7, 8, 9\}$  simultaneously. This observation launches us into the transfinite realm once again, for we think beyond the immediate successor of any finite collection of natural numbers to the immediate successor of the entire collection;  $N = \{1, 2, 3, \dots\}$ . Of course this immediate successor, which Cantor denoted by  $\omega$ , will be infinite because it succeeds every finite number.  $\omega$  is called the **first transfinite ordinal**.

But then, having built a number system on the notion of successors,  $\omega$  would again have an immediate successor itself – a "plus one." *Naturally* this is  $\omega + 1$ . And the immediate successor of  $\omega + 1$  is, *of course*,  $\omega + 2$ . Then  $\omega + 3$ . And  $\omega + 4$ . And so on indefinitely. Thus we have the *ordinal numbers*:

$$1, 2, 3, \dots, \omega, \omega + 1, \omega + 2, \omega + 3, \dots$$

What lies beyond the last ellipsis? These transfinite ordinals are followed by many, infinitely many, other transfinite ordinals. We have  $\omega + 1, \omega + 2, \omega + 3, \omega + 4, \dots$ . What could the immediate successor of this collection of ordinals be? Since each of these numbers is simply  $\omega$  plus a natural number, the immediate successor should be  $\omega$  plus the immediate successor of all the natural numbers. But this is just  $\omega$ . Thus, the immediate successor of the ordinals  $\omega + 1, \omega + 2, \omega + 3, \dots$  is the transfinite ordinal  $\omega + \omega$ . Certainly  $\omega + \omega$  is deserving of the symbol  $2\omega$ . And then we can begin again:

$$1, 2, 3, \dots, \omega, \omega + 1, \omega + 2, \omega + 3, \dots, 2\omega, 2\omega + 1, 2\omega + 2, 2\omega + 3, \dots, 3\omega, 3\omega + 1, 3\omega + 2, 3\omega + 3, \dots$$

1. Above we showed how the transfinite ordinal  $2\omega$  arose. Show how the transfinite ordinal  $3\omega$  arises.
2. Show how the transfinite ordinal  $4\omega$  arises.

3. Show how the transfinite ordinal  $5\omega$  arises.
4. Can you generalize Investigations 1-3 to show how the transfinite ordinal  $n\omega$  arises where  $n$  is any natural number? Explain.
5. Now that we have the transfinite ordinals  $\omega, 2\omega, 3\omega, 4\omega, \dots$  what is their immediate successor? Explain.
6. Explain why it is appropriate to write the transfinite ordinal just obtained as  $\omega^2$ .
7. Now we begin again with  $\omega^2$  forming  $\omega^2 + 1, \omega^2 + 2, \omega^2 + 3, \dots$ . What is the immediate successor of this collection?
8. Show how one obtains the transfinite ordinal  $\omega^2 + \omega + 3$ .
9. After passing by several more limiting processes, we arrive at the transfinite ordinal  $2\omega^2$ . Then, after several more limiting processes  $3\omega^2$ . Then  $4\omega^2$ . And  $5\omega^2$ . Etc. What is the immediate successor of this collection?
10. Explain why it is appropriate to write the transfinite ordinal just obtained as  $\omega^3$ .
11. If we skip even more intervening limiting processes, we can go from  $\omega^3$  to  $\omega^4$ . Then to  $\omega^5$ . And then to  $\omega^6$ . Etc. What is the immediate successor of this collection?
12. Explain why it is appropriate to write the transfinite ordinal just obtained as  $\omega^\omega$ .
13. If we skip even more intervening limiting processes, we can go from  $\omega^\omega$  to  $\omega^{2\omega}$ . Then to  $\omega^{3\omega}$ . Then to  $\omega^{4\omega}$ . Etc. What is the immediate successor of this collection?
14. Explain why it is appropriate to write the transfinite ordinal just obtained as  $\omega^{\omega^2}$ .
15. Explain how we can form  $\omega^{\omega^\omega}$  starting from  $\omega^{\omega^2}$ .
16. In Chapter 1 we wrote truly large numbers using powers of 10. Using this as an analogy, describe the largest transfinite ordinal you can.
17. Can you describe the immediate successor of the ordinal just described? Explain.

The rigorous construction of the cardinal numbers is essentially as we have explored in lesson 5. Some critical subtleties necessary to rigorously construct the ordinal numbers have been replaced here by intuitive suggestions. If we relax our standards of rigor slightly more we will be able to glimpse a more fabulous number system which transcend even the ordinals – the *surreal numbers*.

In addition to the basic transfinite ordinal  $\omega$  we were able to construct many other transfinite ordinals above. This includes numbers like  $\omega^2, \omega^2 + \omega + 3, 3\omega^2, \omega^3$ , and  $\omega^\omega + 1$ . This may suggest that we can use any of the standard operations of arithmetic (addition, subtraction, multiplication, division, exponentiation) to construct new ordinal numbers from  $1, 2, 3, \dots$  and  $\omega$ . In fact, we might even enthusiastically hypothesize that all transfinite ordinals can be constructed in this way.

Alas, we begin to realize there are arithmetic combinations of ordinals that are notoriously missing. Where for example might we find  $\omega - 1$ ? But  $\omega$  was defined to be the immediate successor of all of the natural numbers  $1, 2, 3, \dots$ . It appears that there is no "room" for  $\omega - 1$  as an ordinal.

### 3. The Surreal Numbers

In response to the challenge of an arithmetic of transfinite ordinals, in the mid 1960's **John Horton Conway** (English Mathematician; 1937 - ) created a new number system that dealt with these difficulties. This number system, called the *surreal numbers*, found a place for numbers such as  $\omega - 1$  and  $\frac{1}{\omega}$ . The latter is of historical import. For as described in the introduction to this chapter the "evanescent" infinitesimal had long troubled the foundations of calculus. Yet consider the possible meaning of  $\frac{1}{\omega}$ . As  $\omega$  succeeds all of the natural numbers we have  $1 < \omega, 2 < \omega, 3 < \omega, \dots$ . But this means that  $\frac{1}{\omega} < 1, \frac{1}{\omega} < \frac{1}{2}, \frac{1}{\omega} < \frac{1}{3}, \dots$ . Certainly  $\frac{1}{\omega}$  should be non-negative. We wouldn't expect it to be equal to zero since there are transfinite ordinals beyond  $\omega$  whose reciprocals should be smaller than  $\frac{1}{\omega}$ . But the numbers  $1, \frac{1}{2}, \frac{1}{3}, \dots$  get smaller and smaller. In fact, they get indefinitely close to 0.  $\frac{1}{\omega}$  is thus between 0 and points that become indefinitely close to zero. It is exactly Berkeley's "ghost of a departed quantity" in the flesh. It is not zero, but it is smaller than any real number we can name. It is an infinitesimal! Yet it is not the only one.  $\frac{1}{\omega+1}$  is another, as is  $\frac{1}{\omega^\omega}$ , and etc. ; an infinity of infinitesimals trapped between 0 and the smallest of the small!

18. Explain why the term "ordinal" is an appropriate title for the ordinal numbers.
19. Explain why the term "cardinal" is an appropriate title for the cardinal numbers.
20. What does the term "surreal" mean? Why do you think Conway chose this as a name for the surreal numbers?

Use your knowledge about the relative sizes of ordinal numbers to decide which of the following surreal numbers is larger:

21.  $\frac{1}{\omega}$  and  $\frac{1}{\omega+1}$ .

- 22.  $\frac{1}{\omega^2}$  and  $\frac{1}{\omega}$ .
- 23.  $3\omega - 1$  and  $\omega^2$ .
- 24. 0 and  $\frac{1}{\omega^{\omega}}$ .

The surreal numbers are best introduced *inductively*, that is step by step. We start from its most basic units:  $\uparrow$  and  $\downarrow$ . When these symbols appear by themselves, they represent 1 and  $-1$  respectively. But in conjunction with other occurrences of these symbols you can only determine the value of the arrows in relation to the other symbols that appear.

As we introduce the surreal numbers in this fashion it is most enlightening to organize them into a tree. The first several steps are shown below:

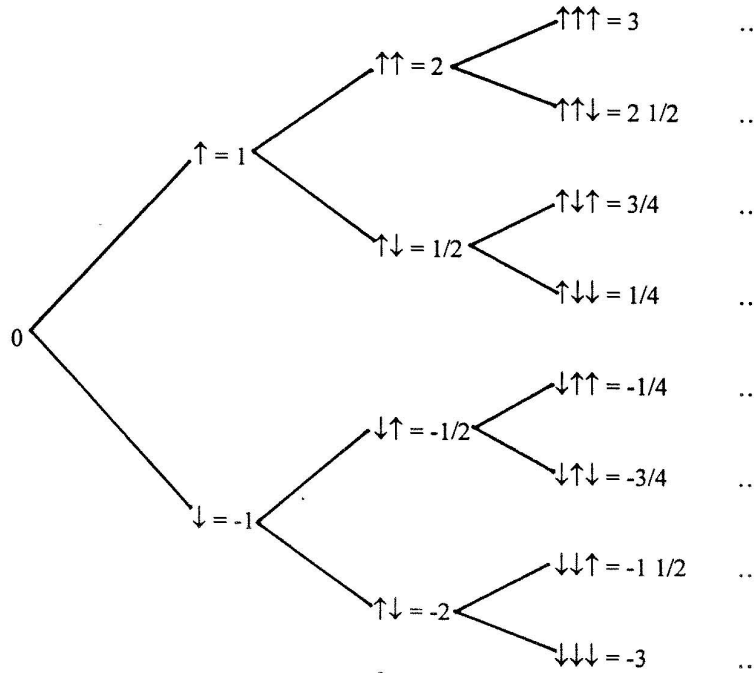

FIGURE 1. Surreal number tree.

Following the pattern in the tree above, write each of the following real numbers as surreal numbers:

- 25. 4.
- 26.  $2\frac{1}{2}$ .
- 27. 9.
- 28.  $\frac{3}{8}$ .
- 29.  $\frac{5}{16}$ .

Following the pattern in the tree above, write each of the following surreal numbers as real numbers:

- 30.  $\uparrow\uparrow\downarrow\uparrow$ .
- 31.  $\uparrow\downarrow\downarrow\uparrow\uparrow$ .
- 32.  $\uparrow\downarrow\uparrow\uparrow\uparrow$ .
- 33.  $\uparrow\downarrow\downarrow\uparrow\uparrow$ .
- 34. Write the natural numbers 5, 6, 7, and 8 as surreal numbers.
- 35. Can you think of a way to write  $\omega$  as a surreal number? Is there any way to abbreviate this notation to a reasonable size? Explain.

#### 4. Genesis of the Surreal Numbers

The surreal numbers were invented in the early 1970's by **John Horton Conway** (English mathematician; - ). Conway is a powerful and prodigious mathematician. One of his areas of specialty is games. Shortly we will see a wonderful connection between the surreal numbers and games.

But first a note about how the world learned about surreal numbers is an order. Conway ate lunch with **Donald Knuth** (; - ) one day shortly after he invented the surreal numbers. Knuth was clearly interested

in the topic as less than a year later he decided to explore these numbers in detail. While he did the research needed to understand this number system he began thinking about how one might teach others about these numbers. He decided to write a novelette, entitled Surreal Numbers: How Two Ex-students Turned on to Pure Mathematics and Found Total Happiness, about how people would go about developing such a theory. In the postscript he says:

As the two characters in this book gradually explore and build up Conway's number system, I have recorded their false starts and frustrations as well as their good ideas and triumphs. I wanted to give a reasonably faithful portrayal of the important principles, techniques, joys, passions and philosophy of mathematics, so I wrote the story as I was actually doing the research myself.

Hmmm... Although our book is not a novelette, we hope that some of these things have characterized your exploration through this book; that you have experienced frustrations as well as good ideas and triumphs; felt joy and passion.

There is another parallel between Knuth's goals with his novelette and our book:

I wanted to provide some material that would help to overcome one of the most serious shortcomings in our present educational system, the lack of training for research work; there are comparatively little opportunity for students to experience how new mathematics is invented, until they reach graduate school.

I decided that creativity can't be taught using a textbook, but that an "anti-text" such as this novelette might be useful... My aim was to show how mathematics can be "taken out of the classroom and into life," and to urge readers to try their own hands at exploring abstract mathematical ideas.

Hmmm... An "anti-text"; kind of like this book?

This book, this novelette, a piece of literature, was in fact the first way in which the world learned about surreal numbers. Up to the point of its publication, this system had not appeared elsewhere in print!

## 5. The Hackenbush Game

I love mathematics not only for its technical applications, but principally because it is beautiful; because man has breathed his spirit of play into it, and because it has given him his greatest game - the encompassing of the infinite.

**Rosza Peter** (Hungarian mathematician; - )

Hackenbush is a game played by two players. Usually the players are Red and Blue, the line segments are colored red and blue, and the line segments can be oriented in any desired way. Here, since we are primarily interested in the connection to surreal numbers, our players will be Up and Down. The playing board for a Hackenbush game, also called *beginning position*, is a collection of line segments made up of  $\uparrow$ 's and  $\downarrow$ 's. The *only* condition on these segments is that from any point on any segment you can eventually reach the ground by travelling continuously along the arrows. I.e. no arrow can be disconnected from the ground.

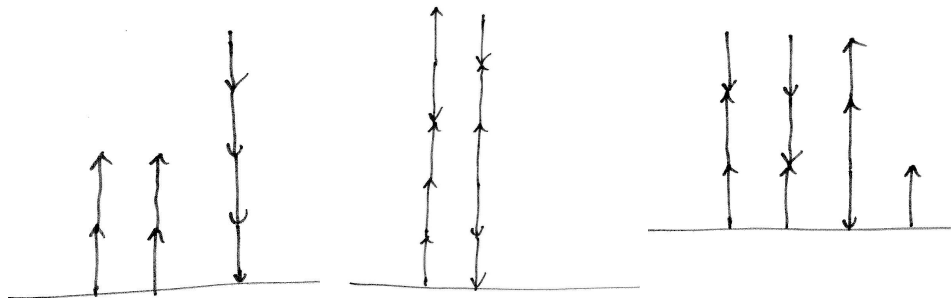

FIGURE 2. Hackenbush beginning positions.

Several beginning positions are shown in Figure 2.

To play the game players take turns removing one of their arrows. They can remove any single arrow that they want. When this arrow is removed, all arrows that are no longer connected to the ground are also



removed. Turns alternate. If a player cannot move on their turn (because they have no arrows left), they lose.

A sample game is shown in Figure 3. Here Down begins and in the last frame Up will remove their  $\uparrow$ . Because there are no  $\downarrow$ 's left, Down loses as they have no move.

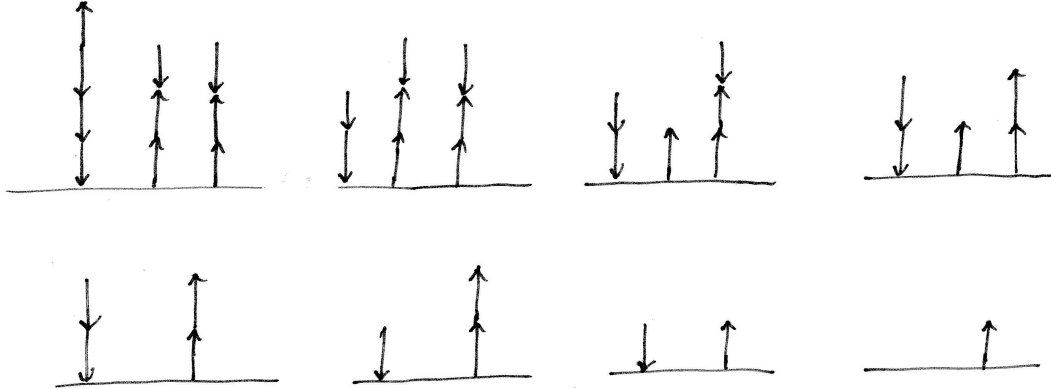

FIGURE 3. A sample Hackenbush game.

36. Choose an opponent. Use the second beginning position shown in Figure 2 to play a game of Hackenbush. Record your moves and the winner.
37. HackenbushGame1Switch Now switch roles - let the person who played second play first. Now replay the game from Investigation 36. Was the outcome the same or different?
38. Repeat Investigation 36 and Investigation ?? for the third beginning position shown in Figure 2
39. Now make up your own beginning position and play another game.
40. Have your opponent make up a beginning position and play another game.
41. Are you starting to get an idea how the strategy of this game works? Explain.

So what is the connection to surreal numbers? In playing the game in Investigation 36 you should have seen that the second player to play was always going to be the winner. When this happens this is called a **null Hackenbush game**. Let us think of what the arrows in the beginning board for this null Hackenbush game represent in surreal terms. The first chain represents the surreal number  $\uparrow\uparrow$  which is the integer 2. The same is true for the second chain. The third chain represents the surreal number  $\downarrow\downarrow\downarrow$  which is the integer  $-4$ . The fact that this is a null Hackenbush game means, in surreal terms,  $\uparrow\uparrow + \uparrow\uparrow + \downarrow\downarrow\downarrow = 0$ . In other words this Hackenbush game proves the surreal analogue of the equation  $2 + 2 + (-4) = 0$  which we normally read as  $2 + 2 = 4$ .

This is not very exciting with finite numbers where we are used to the arithmetic already. What's interesting is to use Hackenbush games for surreal numbers that are uniquely surreal.

In each of the examples below we have infinitely many arrows, denoted as usual with an ellipsis. When you play the Hackenbush game and remove an arrow, you must explain precisely what arrow you have removed. E.g. your move can be to remove the 37<sup>th</sup> arrow.

42. Play the Hackenbush game in Figure 4 several times. Is this a null Hackenbush game?
43. What surreal arithmetical statement does this Hackenbush game correspond to? Explain.
44. From this arithmetical statement, what surreal number do you think  $\uparrow\downarrow\uparrow\uparrow\downarrow \dots$  represents? Explain.
45. Now play the Hackenbush game in Figure 5 several times. Is this a null Hackenbush game?
46. What surreal numbers are represented by this Hackenbush game? Explain.
47. What arithmetical statement would this correspond to if this was a null Hackenbush game?
48. What do Investigation 45 through Investigation 47 tell you about addition with surreal numbers?

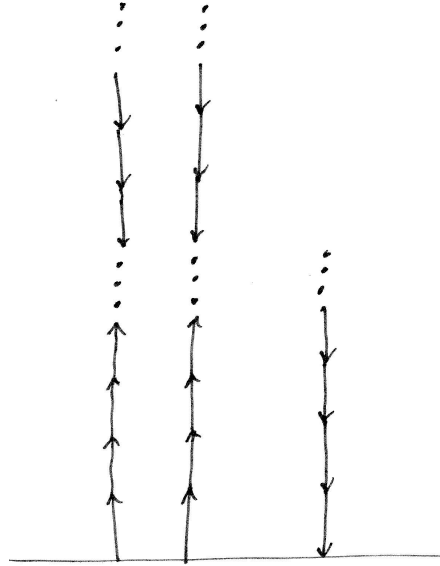

FIGURE 4. Hackenbush beginning positions with  $-\omega$ .

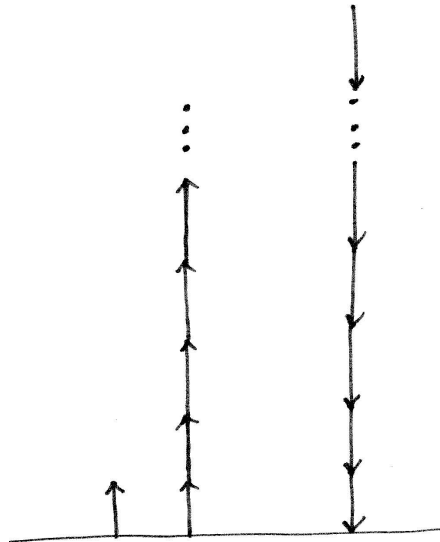

FIGURE 5. Hackenbush beginning positions with  $-\omega - 1$ .

# Index

- $p$ -adic numbers, 37
- , Archimedes, 5
- , Galileo, 1
- , Zeno of Elea, 24
  
- a priori, 3
- Abel, Neils Henrik, 42, 44
- absolutely convergent, 42
- Achilles and the Tortoise, 24
- Age of Analysis, 3, 32
- aleph, 56
- algebraic numbers, 59
- algorithm, 31
- almost all, 4
- alternating harmonic series, 44
- Augustine, Saint, 1
- Avagadro's number, 7
- axiom of choice, 61
  
- bases, 52
- beginning position, 73
- Berlinghoff, William P., 39
- Bernoulli, Jakob, 18
- Big Bang Theory, 5
- Blake, William, 1
- Borge, Jorge Luis, 12
- Bourbaki, Nicholas, 81
- Bressoud, David, 39
  
- Cantor's diagonalization, 88
- Cantor's theorem, 55
- Cantor, Georg, ix, 1, 19, 39, 51, 65, 69, 87
- Cantor, George, ix
- Cantor-Schroder-Bernstein theorem, 62
- cardinal numbers, 56
- cardinality, 20, 53
- Carroll, Lewis, 10
- Cassini, Giovanni Domenico, 18
- Cassinian oval, 18
- Cauchy, Augustin Louis, 32
- Chuquet, Nicolas, 9
- closed-term algebraic expression, 11
- Cohen, Paul, 61
- commutative law of addition, 49
- complementary base pairing, 53
- complete, 32
- complete, Archimidean, ordered field, 32
- completed infinities, 56
- complex, or imaginary, numbers, 3
- concurrent, 21
- conditionally convergent, 46
- consistent, 61
- constructivists, 49
- continuum, 59
- continuum hypothesis, 60
  
- converge, 50
- converge absolutely, 37
- converges, 36
- converging, 41
- Conway, John H., 10
- Conway, John Horton, 4, 71, 72
- cosmological, 5
- Courant, Richard, 57
  
- Dedekind, Richard, 49
- DeMorgan, Augustus, 80
- Deoxyribonucleic acid, 52
- Dirichlet, Peter Lejeune, 49
- distributed computing, 12
- divergent series, 43, 44
- diverges, 36
- DNA, 12
- DNA base pairs, 52
- Douglass, Frederick, xi
- Doyle, Sir Arthur Conan, 78
- Drosnin, Michael, 13
- Dunham, William, 61
- Duotrigintillion, 10
  
- edges, 52
- Egorov, Dimitri, 49
- Einstein, Albert, v, 2
- elements, 20
- ellipsis, 20
- elliptic functions, 18
- empiricists, 49
- empty set, 55
- Enlightenment, 12
- Euler, Leonard, 43, 46
- eventually repeating, 85
- exponential growth, 11
  
- Fermat's Last Theorem, vii
- first transfinite ordinal, 69
- Fjelstad, Paul, 37
- Fleron, Julian F., 48
- Fleron, Lou Jean, 8
- Florensky, Pavel, 49
- Fontenelle, Bernard de, 5
- formal definition, xii
- formalists, 49
- Fourier, Jean Baptiste Joseph, 39
- fractals, 34
- Frances, Diana, 13
- function, 53
- functions, 20
  
- Gödel, Kurt, 62
- Gabriel's Horn, 47
- Gabriel's Wedding Cake, 48
- Galileo's paradox, 54

- Gallivan, Britney, 10
- Gamow, George, 57
- Gandhi, Mahatma, v
- Gauss, Carl Friedrich, 1
- generalizing, 36
- geometric series, 36
- Gödel, Kurt, 61
- Grandi series, 43
- Grandi, Guido, 43
- Grant, Kerry E., 39
- Gregory series, 50
- Gregory, , 50
- Guy, Richard K., 10
  
- Hackenbush game, 4
- half twist, 19
- Haller, Albert von, 25
- harmonic series, 43
- Hilbert's problems, 61
- Hilbert, David, 1, 2, 51, 57
  
- immediate successor, 69
- inclusion, 20
- incommensurable, 3
- inductively, 71
- infinite ordinals, 60
- infinite series, 31
- infinitesimal, 3, 39
- informal definition, xi
- innumeracy, 9
- intersection, 20
- irrationals, 3
  
- Joyce, David, 77
  
- Kasner, Edward, 5, 86
- Kennedy, John F., 13
- King, jr., Martin Luther, 13
- Knuth, Donald, 72
- Kronecker, Leopold, 66
  
- Lavine, Shaughan, 2
- Leibniz, , 50
- Leibniz, G.W., 3
- lemniscate, 18
- limits, 41
- Listing, Johann Benedict, 19
- Livingston, Dennis, 13
- Luzin, Nikolai Nikolaevich, 49
- Lyons, Brianna, i, 26
  
- Möbius band, 19
- Möbius, August Ferdinand, 19
- McKay, Brendan, 13
- McLaughlin, William I., 42
- Melville, Hermann, 13
- Menninger, Karl, 18
- Mersenne primes, 12
- metaphysical, 19
- metaphysics, 1
- Millennium Prize Problems, 47
- Mills, Anna, 37
- modular arithmetic, 37
- Morrison, Philip, 14
- Morrison, Phyllis, 14
  
- Native American Saying,, v
- natural logarithm, 45
- natural numbers, 18
- nested, 35
- Newman, James, 5, 86
  
- Newton, Isaac, 3, 50
- Nilakantha, , 50
- null Hackenbush game, 74
  
- observable universe, 5
- one-point perspective drawing, 51
- one-to-one, 51, 53
- one-to-one correspondence, 53
- onto, 53
- ordinal numbers, 69
- Oresme, Nicole, 44
  
- p-series, 46
- Papert, Seymour, 2
- paradox, 23
- partial sums, 44
- Pauling, Linus, 2
- Paulos, John Allen, 9
- period, 83
- Perleman, Grigori, vii
- perspective drawing, 41
- Peter, Rosza, 4, 35, 73
- Plato, , viii
- Platonists, 49
- Poincaré, Henri, vii
- point at infinity, 51
- polygons, 52
- power series, 48
- power set, 55
- proof without words, 33
- Proofs Without Words, 83
- Pythagorean order, 3
- Pythagorean society, viii
  
- quadratic equation, 4
- quadrivium, viii
- quarks, 15
  
- rational numbers, 59
- real numbers, 32
- rearrangement, 45
- recursion theory, 4
- regular, 34
- Riemann Hypothesis, 47
- Riemann Zeta Function, 47
- Riemann, Georg Friedrich Bernhard, 46
- Rose, Stephen, 13
- Rucker, Rudolf von Bitter, 69
- Rucker, Rudy, 4, 51
- Russell's paradox, 62
- Russell, Bertrand, 42
- Russell, Bertrand, viii
  
- Sagan, Carl, v
- scaling, 29
- Schrödinger, Erwin, 3
- Schwartz, David M., 15
- set, 19
- set difference, 20
- set theory, 55
- simple, 52
- speed of light, 5
- Square Wheel of Aristotle, 23
- standard form, 81
- subset, 55
- sum, 31
- surreal numbers, 4, 32, 70, 71
- Swift, Jonathan, 26
  
- Theory of Relativity, 5
- Tillotson, Archbishop, 13, 77

Toricelli, Evangelista, 47  
transcendental numbers, 4  
transfinite cardinal numbers, 2  
transfinite cardinals, 1  
transfinite ordinal numbers, 2  
transfinite ordinals, 1  
transfinites, 56  
trivium, viii  
Tufte, Edward Rolf, 14

uncountability, 61  
undecidable, 61  
undefined term, xi  
union, 20  
unit interval, 59  
universe of all sets, 62

vanishing point, 51  
vertices, 52

Wallis, John, 18  
Wechsler, Allan, 9  
Weierstrass, Karl, 32  
Weyl, Hermann, 17  
Wheel of Aristotle, 21  
Wheel Paradox of Aristotle, 23  
Whitehead, Alfred North, 29  
whole numbers, 17

Zeno's dichotomy, 24  
Zermelo-Fraenkel set theory, 61